



New HAL3s

Rane has replaced the HAL3 model with the updated **HAL3s**. The HAL3s does everything the HAL3 does and more!

- **New analog Mic/Line-Plus input stage** adds support for 2 microphone inputs, with or without 48 V phantom power.
- **Additional RAD port:** one DR port becomes a RAD port. This makes the HAL3s a 6-input, 10-output DSP (the HAL3 was 4 x 8). More audio channels means more applications solved.
- **10 dB quieter:** the dynamic range is improved 10 dB — now with 108 dB dynamic range!
- Best of all, the new HAL3s has the **same price** as the HAL3.

Note that your **existing** HAL3 software configuration files are **not** compatible with the new HAL3s. This means system designers should either create brand new HAL3s files to use with the new model, or copy and paste all the HAL3 DSP blocks and wires into a new HAL3s file. Then recreate links, presets or paging management settings. You'll find HAL3s support in the latest version of Halogen software.

HAL System Description

HAL is more than just another DSP drag-and-drop system. It has revolutionized system design and installation.

HAL is an expert in room combining, paging and distributed audio systems. This groundbreaking architecture is dimensions beyond any solution in any industry. HAL easily guides even novice users through what used to be complex tasks in just minutes. No intricate matrix mixing or presets are required for room combining and paging. No virtual wiring is required to distribute pages and background music to multiple, even hundreds of zones.

Seamlessly interface HAL to your application with web controls and/or a broad variety of peripheral devices including smart Digital Remotes, a 7-inch programmable touchscreen, Remote Audio Devices (RADs), portable or rack automixers, expansion devices for logic, wall sensors, ambient sensing mics, and an advanced Paging Station. Control HAL functions from a web browser in any smartphone, computer or tablet – including iPads, iPhones, Androids, Samsung, etc. The Event Manager can trigger events using time-of-day.

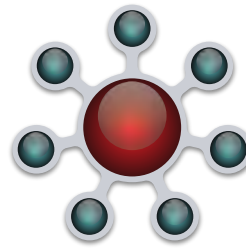

HALOGEN



Includes Customizable Web Controls

In addition, the HAL Multiprocessor and Halogen™ software check the status, location, CAT 5 wiring integrity, and that audio is flowing in all peripheral devices, so you know your system is properly connected and ready to go. Does your DSP troubleshoot the cable install for you and offer a “Get on the Plane” indicator showing you that the installers have finished their job? It should.

Halogen software includes Ethernet control support for third-party control systems such as AMX®, Crestron® and Stardraw Control™, including well-documented examples. Standard TCP/IP set and get ASCII text messages control levels, selectors, presets and toggle software actions. Since the same Halogen software code runs on both Windows® and within HAL hardware, third-party control developers can test all their code using only the Halogen Windows software. Use only software for complete system design and validation. Buy the hardware only when the install date arrives and completely skip needing it early solely for control system programming verification.

Analog audio has always offered “plug it in, it works.” With HAL’s modern DSP system, finally digital audio offers “plug it in, it works.” Without IP anything, without DHCP servers, without unblocking ports, without firmware mismatches, without hours (or days?) of bad cable termination or swapped cable-pull troubleshooting, and other troubles caused by Ethernet and other supposedly modern digital audio and control transports.

Download Halogen and design a system now!

rane.com/hal

Applications, installations, and solutions are at

blog.rane.com

HAL3s

Multiprocessor



HAL Comparison

HAL1x Multiprocessor

- 16 in x 16 out - 8x8 analog & 8x8 digital (RAD ports).
- Up to 4 RADs (without EXP1x), up to 260 RADs (with 32 EXP1s).
- Up to 12 Digital Remotes (without EXPs), up to 268 (with EXPs).
- Four logic inputs, Two relay outputs (more with DR4 or DR5).

Analog Mic / Line Inputs 8	8 Analog Line Outputs
Digital RAD Port Inputs 8	8 Digital RAD Port Outputs
Digital Expansion into HAL1x 512	512 Digital Expansion from HAL1x
Total in the HAL1x DSP Brain 528	528
Inputs	Outputs

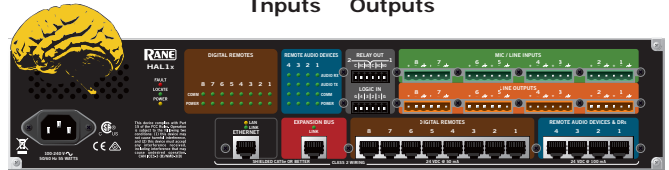
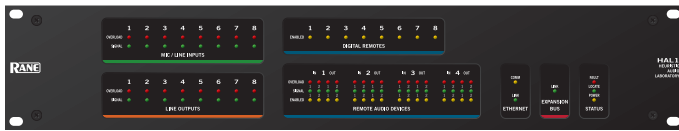

EXP1x Remote Audio Expander for HAL1x



Daisy-chain up to 32 EXPanders

- Adds 16 in x 16 out digital (8 more RAD ports) to HAL1x.
- Up to 8 Digital Remotes or RADs in any combination.
- Chain up to 32 EXP1x units to a HAL1x for 512 in x 512 out.

EXP2x Dante Expander for HAL1x

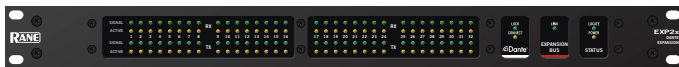

- Enables HAL1x to send / receive 32 channels to Dante devices.
- Supports 44.1, 48, 88.2 or 96 kHz Dante network sample rates.
- Chain up to 16 EXP2x units to a HAL1x for 512 in x 512 out.

EXP3x Zone Output Expander for HAL1x



- Adds 8 analog line outputs and 8 logic outputs to a HAL1x.
- Adds 6 Digital Remote ports & 2 RAD ports to a HAL1x.
- Chain up to 32 EXP3x units to a HAL1x for 256 outputs.

EXP5x Input Expander for HAL1x



- Adds 12 analog mic / line/ line-plus* inputs to a HAL1x.
- Adds 4 Digital Remote ports to a HAL1x.
- Chain up to 32 EXP5x units to a HAL1x for 384 analog outputs.

EXP7x AEC Expander for HAL1x



- Adds 8 channels of Acoustic Echo Cancelling DSP to a HAL1x.
- Chain up to 32 EXP7x units to a HAL1x for 256 AEC channels.

Dante is a trademark of Audinate Pty Ltd, Audinate is a registered trademark of Audinate Pty Ltd.

HAL2 Multiprocessor

- 18 in x 18 out - 8x8 analog & 8x8 digital (RAD ports) & AES3 I/O.
- Up to 8 Digital Remotes.
- Four logic inputs (closure), Two relay outputs.
- Four IR Ports for IR2 Wall Sensors.

Analog Mic / Line Inputs 8	8 Analog Line Outputs
Digital RAD Port Inputs 8	8 Digital RAD Port Outputs
(AES3) Input Channels 2	2 (AES3) Output Channels
Total in the HAL2 DSP Brain 18	18
Inputs	Outputs

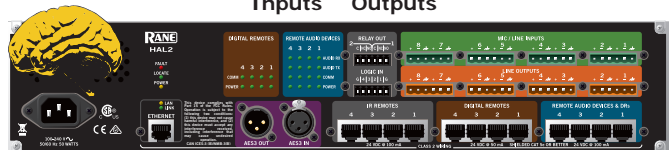
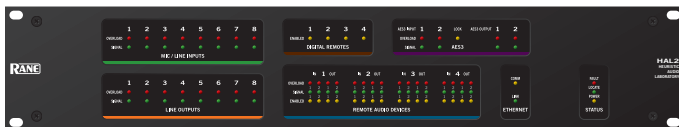

HAL Comparison

HAL3s Multiprocessor

- 6 in x 10 out - 2x6 analog & 4x4 digital (RAD port).
- 2 Mic/Line/ Line-Plus Inputs*.
- Up to four Digital Remotes.
- Four logic inputs (contact closure).



Analog Line-Plus Inputs 2	6 Analog Line Outputs
Digital RAD Port Inputs 4	4 Digital RAD Port Outputs
Total in the HAL3s DSP Brain 6	10
Inputs	Outputs

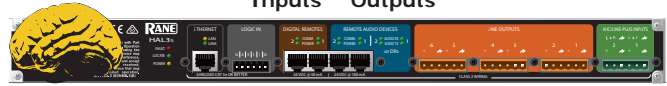

HAL4 Multiprocessor

- * 2 Mic/Line/Line-Plus Inputs can wire "mic level," "mic with phantom," "line level balanced," or "unbalanced L/R monoed."
- 2 balanced line outputs.
- One Digital Remote Port.



Analog Mic/Line-Plus Inputs 2	2 Analog Line Outputs
Total in the HAL4 DSP Brain 2	2
Inputs	Outputs



RAD and DR Cable Lengths

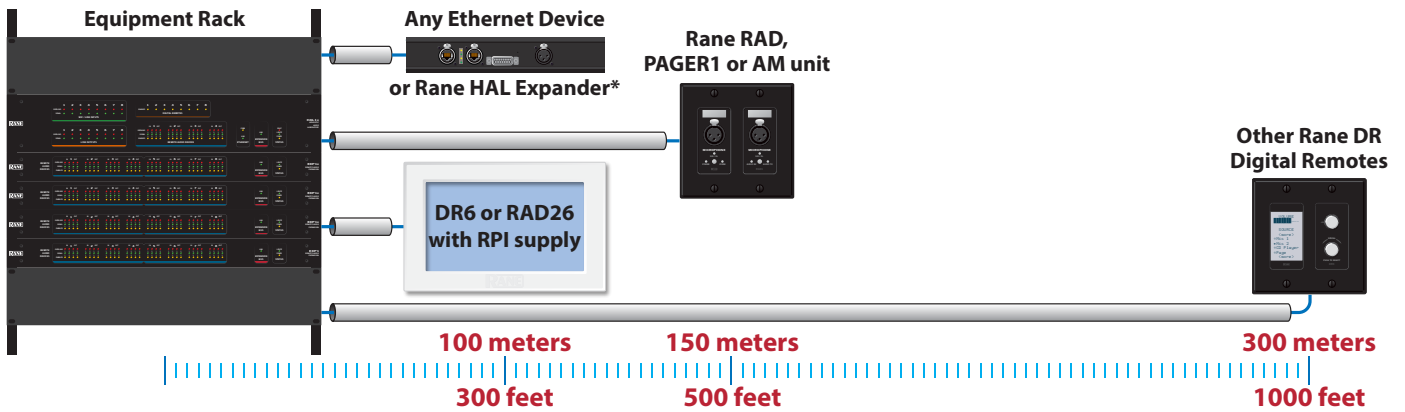

Latency

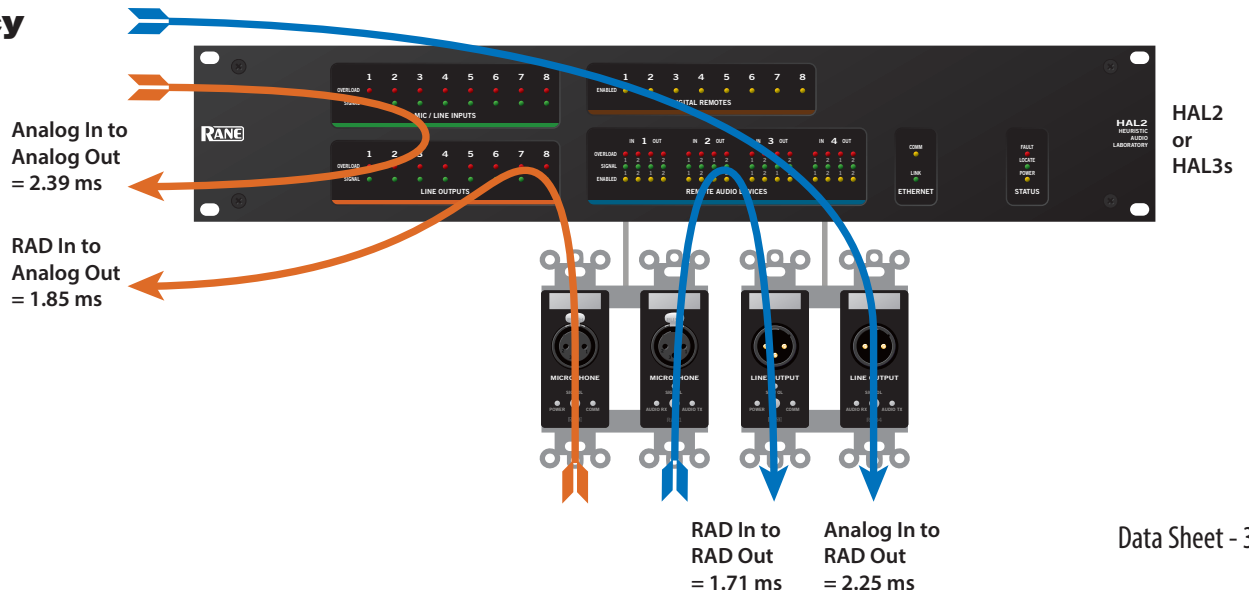

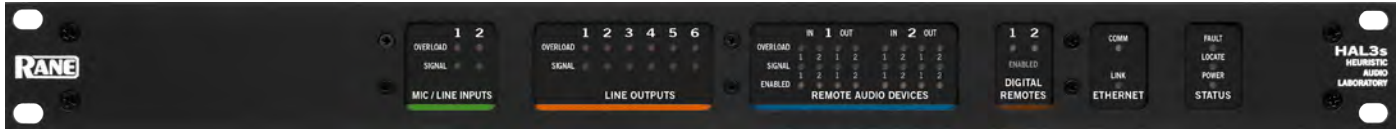

HAL3s Specifications

Parameter	Specification	Limit	Conditions/Comments
Analog I/O	2 x 6		2 Mic / Line / Line-plus Inputs, 6 Line Outputs
...Connectors	Euroblock		4 x 6-pin, 5 mm pitch, Green = Inputs, Orange = outputs
...CODEC	24-bit, 48 kHz		
All Inputs			Common specifications
...Input Impedance	2.9 k Ω	1%	Each leg to ground
...Inter-channel isolation	>100 dB	typ	20-20k Hz, unity gain, channel-to-channel
...CMRR	55 dB	min	1 kHz
Inputs: Dynamic Mic Mode	Active Balanced		Microphone input mode without phantom power
...Gain	+30 dB to +50 dB	typ	+30 dB (analog gain), 1 dB steps to +50 dB (digital gain)
...THD+N	< 0.005 %	typ	20-20k Hz, +4 dBu out, 0 dB digital gain
...Equivalent Input Noise	-120 dBu	typ	20-20k Hz, 150 Ω source, 30 dB gain
...Maximum Input	-18 dBV (125 mVrms)	typ	1 kHz, < 0.01% THD+N
...Frequency Response	20-20k Hz, +0.0 / -0.3 dB		+4 dBu out, 100k Ω load, Mic Input to Output
Inputs: Condenser Mic Mode	Active Balanced		Microphone input mode with 48V phantom power
...Gain	+18 dB to +38 dB	typ	+18 dB (analog gain), 1 dB steps to +38 dB (digital gain)
...Phantom Power	+48 VDC		10 mA max per input
...THD+N	< 0.005 %	typ	20-20k Hz, +4 dBu out, 0 dB digital gain
...Equivalent Input Noise	-110 dBu	typ	20-20k Hz, 150 Ω source, 18 dB gain
...Maximum Input	-6 dBV (500 mVrms)	typ	1 kHz, < 0.01% THD+N
...Frequency Response	20-20k Hz, +0.0 / -0.3 dB		+4 dBu out, 100k Ω load, Mic Input to Output
Inputs: Line+ Mode	Active Summer		Left ("+") and Right ("-") signals summed to mono
...Gain	0 dB to +20 dB	typ	0 dB (analog gain), 1 dB steps to +20 dB (digital gain)
...THD+N	< 0.007 %	typ	20-20k Hz, +4 dBu out, 0 dB digital gain
...Maximum Input	+14 dBu	typ	1 kHz, < 0.01% THD+N, each leg
...Frequency Response	20-20k Hz, +0.0 / -0.3 dB		+4 dBu out, 100k Ω load, Line-plus Input to Output
...Dynamic Range (in to out)	108 dB	max	re +20 dBu, 20 kHz BW, A weighted, Rs = 50 Ω
Inputs: Line Mode	Active Balanced		Balanced line level input
...Gain	0 dB	typ	0 dB (analog gain), 1 dB steps to +20 dB (digital gain)
...THD+N	< 0.005 %	typ	20-20k Hz, +4 dBu out, 0 dB digital gain
...Maximum Input	+14 dBu	typ	1 kHz, < 0.01% THD+N
...Frequency Response	20-20k Hz, +0.0 / -0.3 dB		+4 dBu out, 100k Ω load, Line Input to Output
...Dynamic Range (in to out)	108 dB	max	re +20 dBu, 20 kHz BW, A weighted, Rs = 50 Ω
Outputs	Active Balanced		
...Impedance	200 Ω	1%	Each leg
...Maximum Output	+20.0 / +15.5 dBu	typ	1 kHz, 100 k Ω / 600 Ω load



Parameter	Specification	Limit	Conditions/Comments
Indicators			
...Signal	-50 dBFS	typ	Green LED, peak-reading
...Overload	-0.5 dBFS	typ	Red LED, peak-reading
Propagation Delays			
...RAD In to RAD Out	1.71 ms	typ	Tested with RAD23
...RAD In to Analog Out	1.85 ms	typ	
...Analog In to RAD Out	2.25 ms	typ	
...Analog In to Analog Out	2.39 ms	typ	
DSP			
...Processing Power	2400 MIPS	max	1 DSP @ 300 MHz with up to 8 instructions / cycle
...Word Length	32 / 64-bit Floating Point		
...Delay Memory	20 seconds	max	
Computer Interface			
...Type	Ethernet 1000 base-T		Zeroconf service discovery protocol for easy set up
...Cable	Shielded CAT 5e or better		RJ-45 connector
...Length	100 meters / 300 feet	max	Standard Ethernet cable length limit
RAD Port			
...Audio Channels	2 in x 2 out		Each port 2 in x 2 out, control channel, 24-bit, 48 kHz
...Power	24 VDC @ 100 mA	max	Each port
...Length	152 meters / 500 feet	max	Shielded CAT 5e cable or better
DR Ports			
...Power	24 VDC @ 50 mA	max	Each port
...Length	300 meters / 1000 feet	max	Shielded CAT 5e cable or better
Logic Inputs			
...Connector	Mini Euroblock		6-pin, 3.81 mm pitch, Black
...Internal Pull-up	51.1 kΩ, 5.0 V		Protected to +24 V, reverse polarity protected
...Vin High	> 2.2 V	min	Normal state
...Vin Low	< 0.7 V	max	External circuit sinks > 22 μA to assert
Wiring			
...Requirement	Class 2		All rear panel terminals
Power Requirement			
...Ambient Room Temp.	100 to 240 VAC		50/60 Hz, 20 W max
...Unit: Conformity	40 °C	max	Maximum external loading
...Unit: Size	CE, FCC, cCSAus		
...Weight	1.73"H x 19"W x 8.25"D		(4.4 cm x 48.3 cm x 20.9 cm)
...Shipping: Size	4.75 lb		(2.2 kg)
...Weight	4.25" x 20.3" x 13.75"		(11 cm x 52 cm x 35 cm)
...Weight	9 lb		(3.8 kg)

HAL3s

Multiprocessor



RADs

The entire family of RAD models interface with HAL, for digital conversion at the wall. Each converts analog audio to and/or from 24-bit, 48 kHz digital audio. Shielded CAT 5e (or better) cable and termination transport four digital audio channels – two channels each direction – as well as power, ground and a communications channel, with status indicators at each RAD, HAL or EXP unit, and in Halogen software. HAL auto-checks the CAT 5 crimp and verifies audio. All RADs (and DRs) are both “location-aware” and hot-swappable with 150 meter (500 feet) homerun connections (66% farther than Ethernet). Light sensors dim the RAD indicators in dark rooms. Except for the RAD16z, AM1, AM2, and PAGER1, all RADs mount in standard US electrical boxes. Except for the RAD16z, RAD17, AM1, AM2, and PAGER1, all other RADs are available in white, ivory, or black, with a matched Decora® plate cover included.

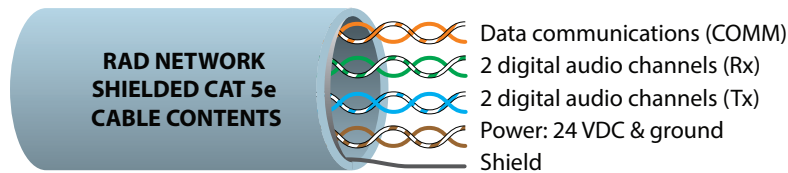

- RAD1 Dual XLR Mic Inputs
- RAD2 XLR Mic Input / Mini & RCA Mono'ed Line Input
- RAD3 Dual XLR Line Inputs
- RAD4 Dual XLR Line Outputs
- RAD5 AES3 Input / AES3 Output
- RAD6 Mini & RCA Stereo Line Input / Stereo Line Output
- RAD7 XLR Mic Input / XLR Line Input
- RAD8 XLR Mic Input / Mini & RCA Stereo Line Output
- RAD9 XLR Mic Input / XLR Line Output
- RAD11 XLR Mic In / Mini & RCA Mono'ed Line In / Mini & RCA Stereo Line Out
- RAD12 Dual XLR Mic Inputs / Dual XLR Line Outputs
- RAD14 XLR Mic In / Mini & RCA Mono'ed Line In / Dual XLR Line Out
- RAD15 Dual XLR Line Inputs / Dual XLR Line Outputs
- RAD16z Dual Mic-Line-Plus Input / Dual Line Output / Dual Logic / Euroblocks
- RAD17 Omnidirectional Boundary Layer Mic
- RAD18 XLR Mic Input / 1/4" Balanced Line Input
- RAD23 XLR Line Input / XLR Line Output
- RAD26 Dual Input - Output - Logic - Amplifier / Source and Level Remote
- RAD27 USB Audio Sound Card
- RADX RAD Port Extension (CAT 5 wall jack for portable RADs)
- AM1 Four-Channel Gain-Sharing Automixer with added Line Inputs
- AM2 Eight-Channel Gain-Sharing Cascadable Automixer
- PAGER1 Mic Preamp with Push-to-Talk and Page Zone Selection

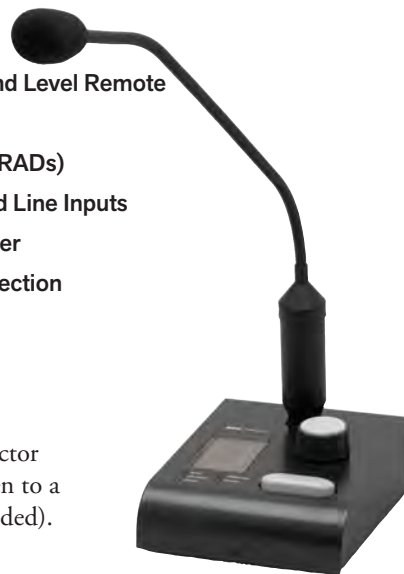
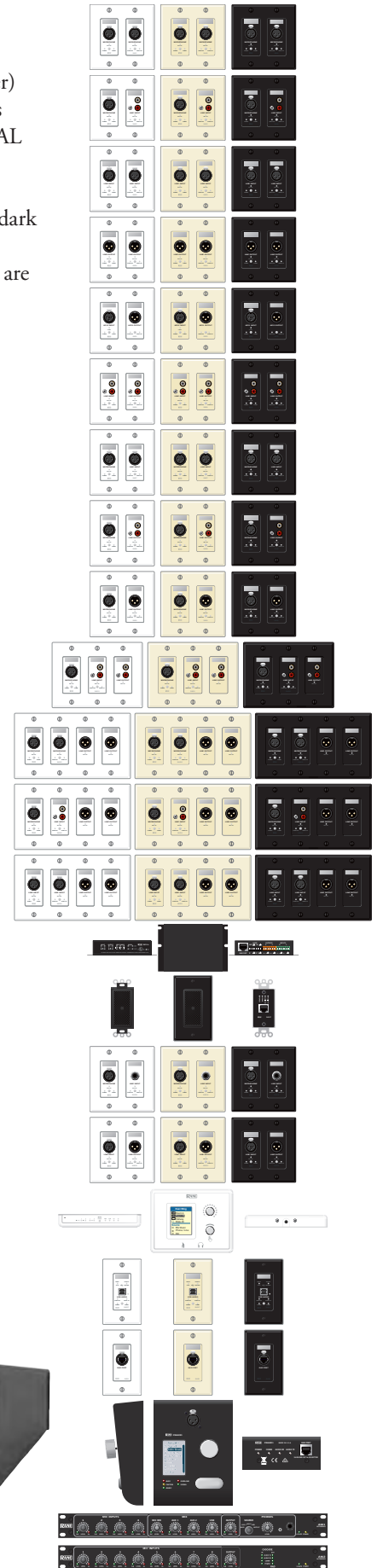

PAGER1

Paging Station

This RAD has a mic preamp, paging zone(s) [Scenario] selector and an integrated push-to-talk switch. It sits on or can fasten to a tabletop, and accepts any gooseneck microphone (not included).

Digital Remotes

Three Digital Remotes simplify end user control and eliminate installer brain fatigue. Use Digital Remotes for volume control, preset recall, source selection, or resetting or toggling system states. All offer customizable backlit LCD screens for intuitive end user labeling. Home run shielded CAT 5e (or better) connections to a HAL or EXP eliminate addressing, external power, and the need to test the cables.

The DR1 supports Level Control.

The DR2 offers Single Selector or List of Toggles/Commands behavior.

The DR3 has three behaviors: Single Level & List of Toggles/Commands, List of Levels for either multizone volume control and/or input source mixing, and Single Level plus Selector.

DR1 Digital Volume Remote



Level Control

DR2 Digital Selection Remote

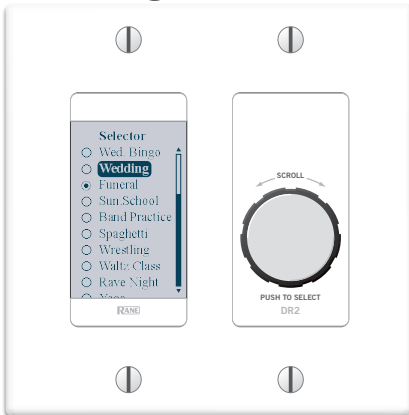

Single Selector

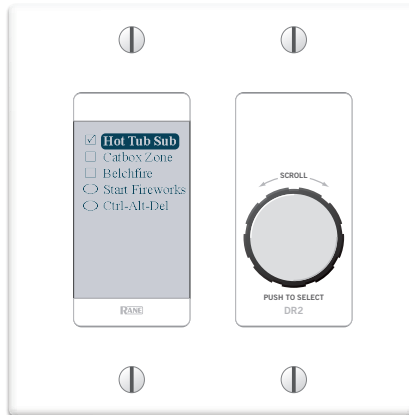

List of Toggles / Commands

DR3 Digital Volume and Selection Remote

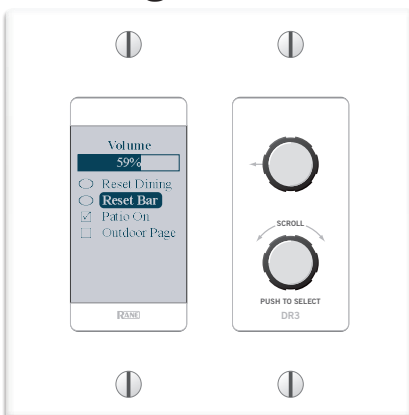

Single Level & List of Toggles / Commands



List of Levels

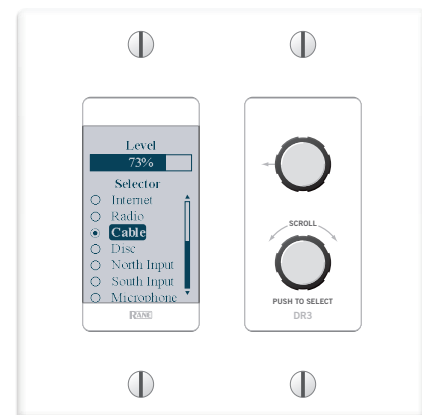

Single Level & Selector

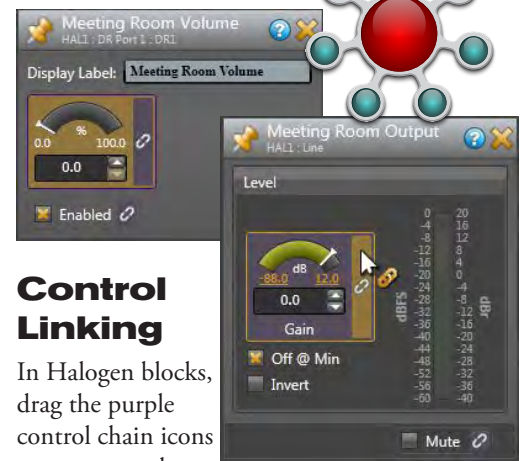

Control Linking

In Halogen blocks, drag the purple control chain icons atop one another to create links between Levels, Toggles, Selectors, Commands, Digital Remotes, Web Controls and/or 3rd-party controls. The above screen shows linking a DR1 volume onto the Meeting Room Output Level control. Four Control Link types and behaviors are supported: Level, Select, Toggle or Command. Activation and Priorities work together for incredible flexibility. Link simple analog remote level controls, contact closures and IR remote wall sensors by adding a DR4 Logic I/O Expander.

DR4 Logic I/O Expander

The DR4 Digital Remote adds additional logic input and output ports to any HAL, enabling simple analog level and logic I/O controls plus IR2 remotes for wall sensing. The DR4 offers eight logic ins and outs, six IR ports and eight analog input ports for

pot-on-a-wall level control. Multiple DR4's can connect to Digital Remote Ports on any HAL, up to 300 meters (1000 feet) away. See the Logic Inputs, Control Inputs and Logic Outputs on the next page.

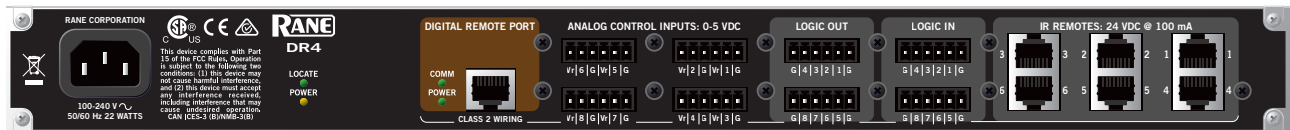

DR5 Switch Controller Remote

The DR5 Digital Remote offers additional logic input and output ports, enabling the use of simple analog switch controls in any HAL system. Lighted switch panels for room combine applications are easily integrated into a HAL system using the eight switch inputs and eight LEDs outputs on the DR5. Unlike the HAL and DR4 Logic I/O, the DR5 Logic Out is intended to drive the LED indicator on a room combine panel, and is a writable parameter. The DR5 is designed to fit in a standard US dual-gang electrical box or mount directly near a room combine panel.

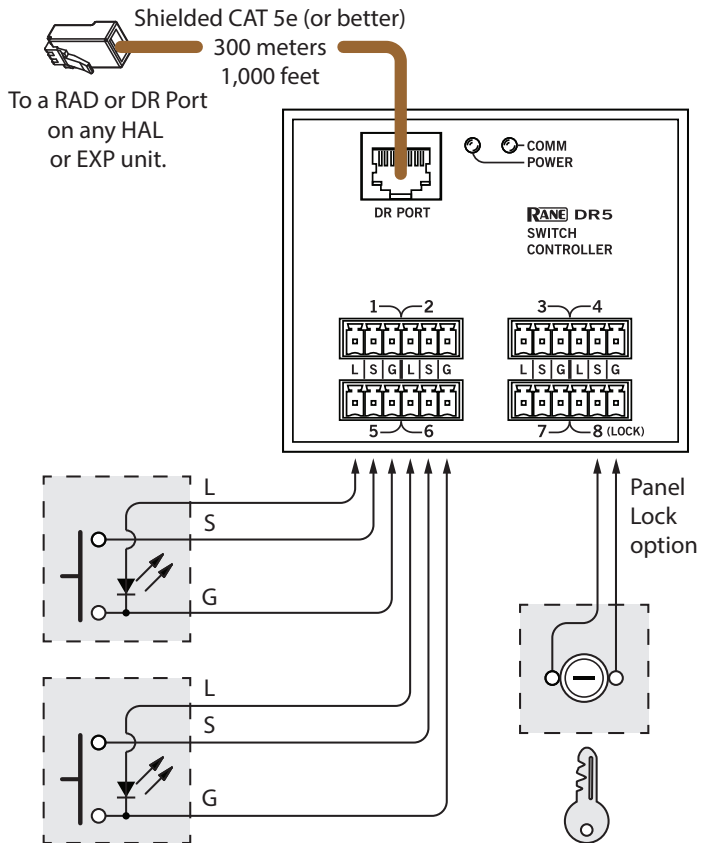

DR6 Touchscreen Remote

The DR6 is a fully customizable touchscreen remote for the HAL family. It supports multiple pages or tabs and any set of levels, toggles, selectors and/or commands. Drag, drop and resize controls any way that's desired. Use custom background images and logos in full-color on the 7-inch LCD display.

Screw the included wall-mount bracket over U.S. or international electrical boxes, or flush mount the $\frac{3}{4}$ " thick DR6 with a 2-inch hole in the wall to accommodate the cable. The optional DS1 desk stand accessory (shown) allows the DR6 to mount on a horizontal surface. The optional RB1 rack bracket installs the DR6 in a 19" equipment rack.

The included midspan power injector connects CAT5e (or better) cables between any HAL and the DR6 to deliver communications and the extra power needed for the display.

Optional, on-screen User Access logins secure management pages from public or staff use, and a programmable ambient light sensor automatically dims the backlight.

The Control Page Designer in Halogen 5.0 allows you to create one set of pages and use them in a web control design, DR6 display or both.

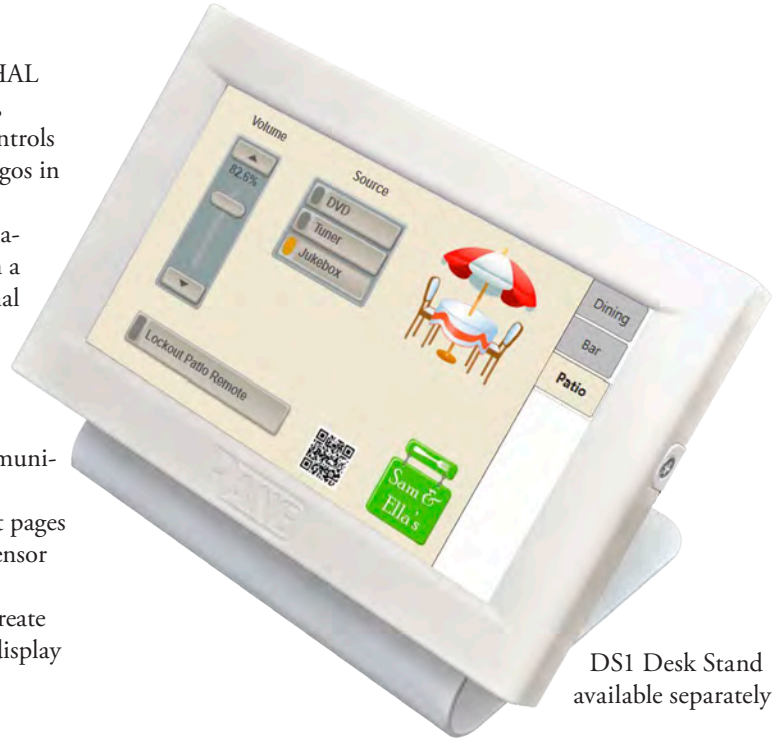

DS1 Desk Stand available separately

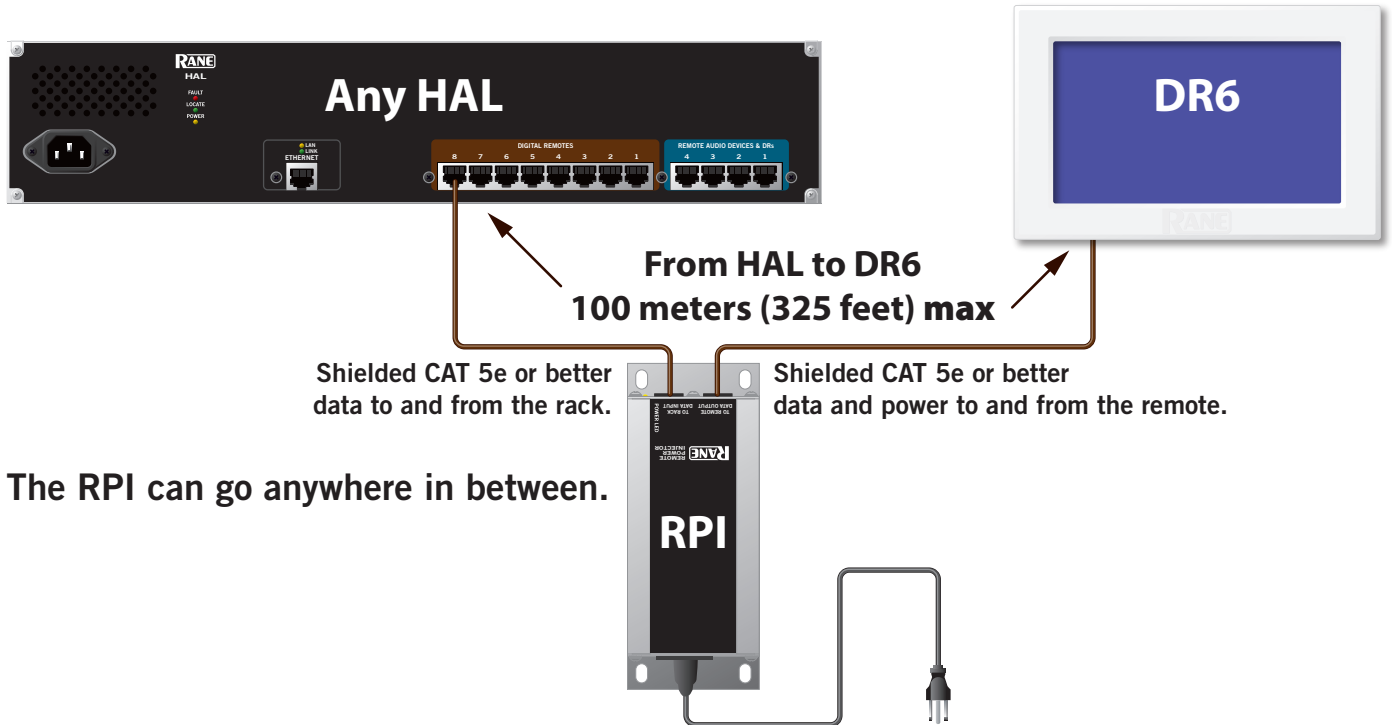

DS1 Desk Stand Accessory

- All steel, painted white.
- Rubber bottom protects the desktop.
- Kensington security hole.
- Holes in the bottom to fasten to a desktop.
- Larger hole in bottom to thread CAT 5 cable through the desktop.



RB1 Rack Bracket Accessory

- All steel, painted black, 3U rack height.



Halogen Web Controls

Control the Levels, Selectors, Toggles and Commands in any HAL System from **any device with a web browser**. Halogen's Web Controls feature allows creation of custom HTML GUI control screens. Define the quantity of control pages, and the layout, labeling and size of each control, and completely test them using your default web browser from within Halogen.

Access any control page from any browser-enabled device on the network with a HAL device. Just open a browser and type in the customizable IP/webpage address for the HTML page – and bookmark it for easy access. Type in an optional User Access code, and voilà, the trick, she is done! Control your HAL system wirelessly from one or more tablets, smart phones, laptops or desktop computers. The HAL web server is multi-client, allowing control across many devices and many rooms. You can link Rane's wired DR remote controls (DR1, DR2, DR3 & DR6) and wireless devices and they'll automatically track each other.

Customers are asking for "iPad control" and Halogen's Web Controls is the solution. It is not Apple®-centric — no iTunes® store or app installs required. We'll save a lot of ink on this page not listing all the possible devices that support web browsers and wireless Ethernet. Besides, the list will change before the ink dries.

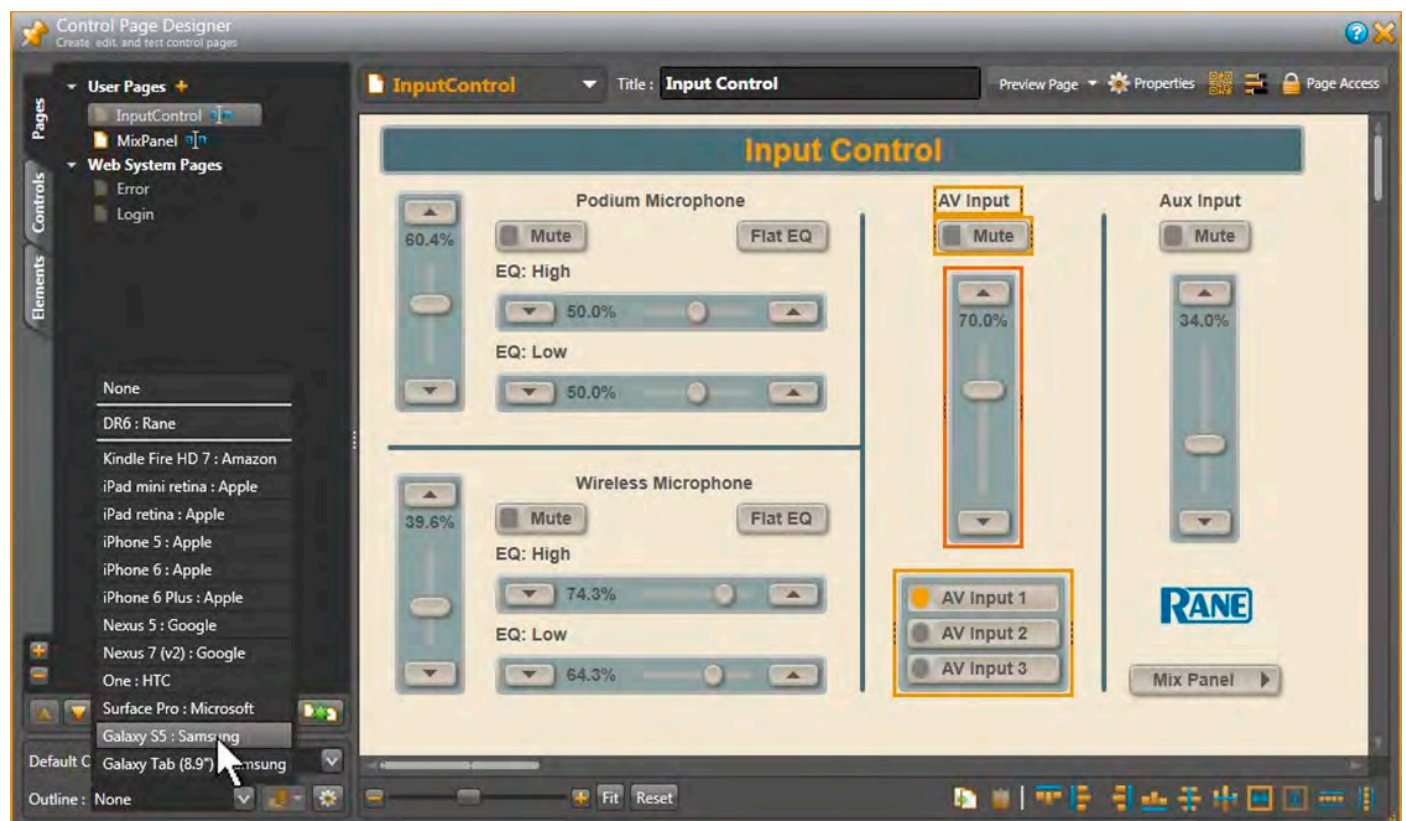
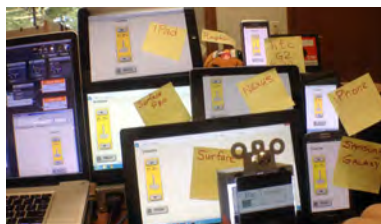

HAL3s Logic Inputs

These inputs are found on the HAL3s. More can be added with the DR4 or DR5, connectable to any DR port. You can configure each of the Logic Input ports in one of three ways: toggle, command, or selector.

The **Toggle** configuration allows a Toggle command with an on/off switch. You can configure each port type to be either *Momentary* or *Latching*.

The **Command** configuration allows triggering a Command control from an on/off switch, which can link to one or more Command controls such as a Command preset or a linkable button in a processing block property dialog.

The **Selector** configuration uses either a multi-position switch or a binary switch. You can connect a physical device to any or all of the Logic In ports and configure the ports in Halogen so they make the desired selection according to the state of the physical device. Wiring details are in the Halogen Software Help. The Selector configuration is not supported by the DR5.

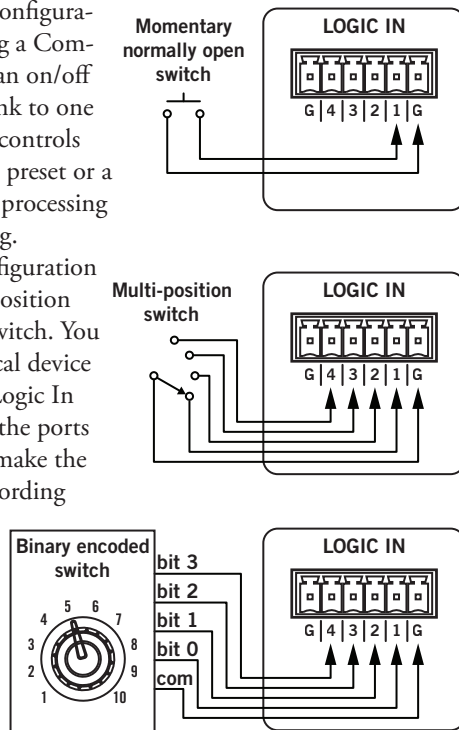

Halogen Processing Blocks

Dynamics

- Ambient Noise Compensator (ANC)
- Automatic Gain Control (AGC)
- Compressor
- Ducker
- Expander
- Gate
- Limiter

Misc. blocks

- Level
- Delay: simple
- Delay: distance
- Delay: video
- Signal Meter
- Pink Noise: Simple
- Pink Noise: Ramped
- Pink Noise: Swept
- Sine Wave generator
- Voice Detect

Filters

- Feedback Suppressor
- Cut Filter
- Shelf Filter: single
- Shelf Filter: multichannel
- Parametric EQ: single
- Parametric EQ: multichannel
- Graphic EQ
- FIR Filter
- Crossover: 2-way mono
- Crossover: 3-way mono
- Crossover: 4-way mono
- Crossover: 2-way stereo
- Crossover: 3-way stereo
- Crossover: 4-way stereo
- Crossover: all-pass
- Crossover: CD horn

Mixers

- Mixer: 2 to 80 inputs
- Matrix Mixer
- Gain-sharing Auto Mixer
- Gain-sharing Auto Matrix Mixer

Selectors

- Selector: 2 to 80 inputs
- Priority Selector
- Router: 2 to 80 outputs

Paging and Room Combine

- Distributed Program Bus
- Paging Station with 2-band PEQ, Compressor, Level
- Paging Zone
- Emergency Page Zone
- Zone Processor with Priority Selector, Level, Paging Zone

Example HAL3s Restaurant / Bar Music and Paging System

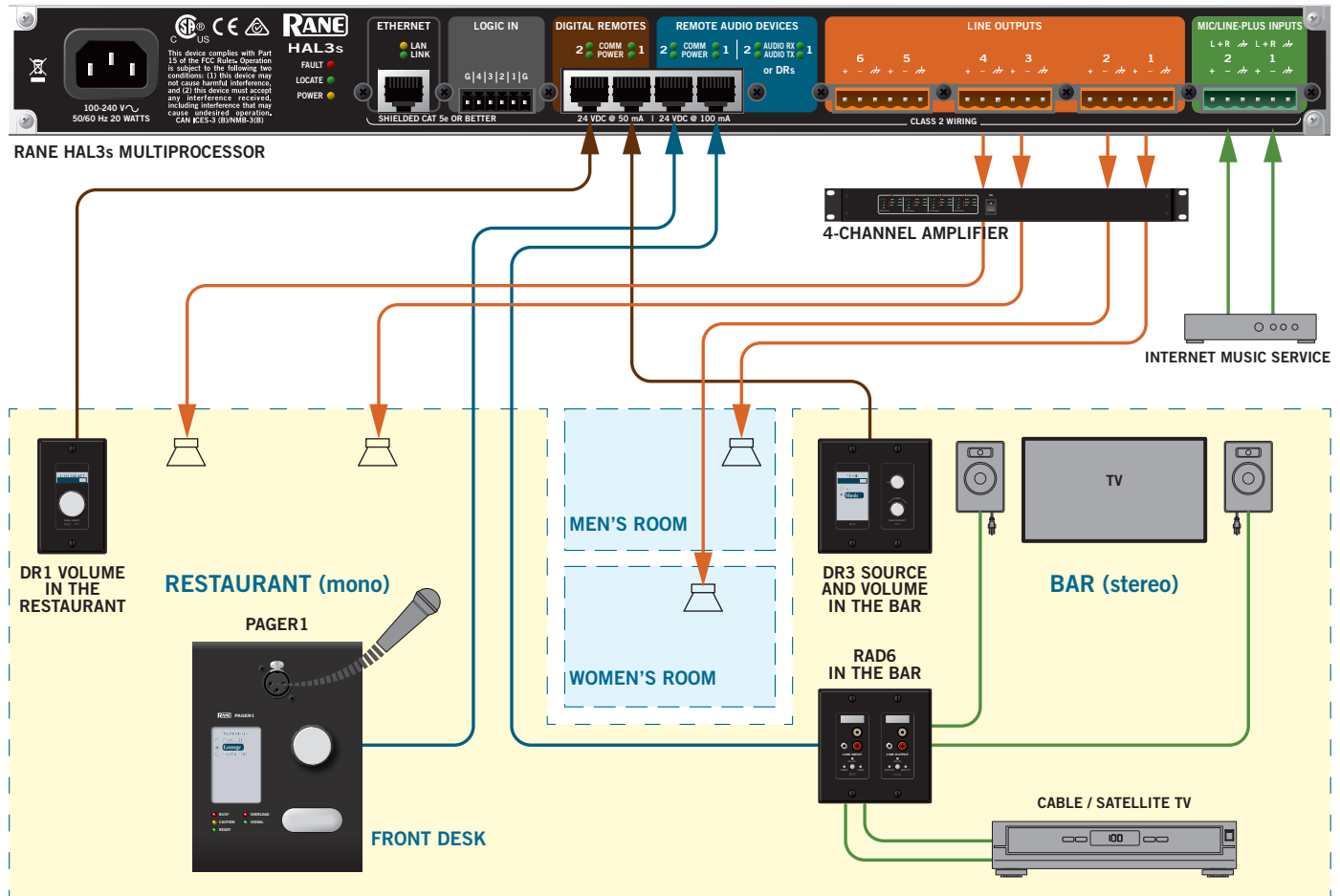

The Lounge area has stereo powered speakers on each side of the flatscreen TV.

The Restaurant and restroom audio is mono. A Rane MA4 Amplifier directly drives each of the four speakers.

The source selection for all zones is the DR3 Remote in the Lounge. The DR3 volume only controls Lounge audio.

A DR2 in the restaurant controls the volume for the restaurant and restrooms. An MA4 Amplifier provides four channels @ 100W.

The HAL3s Mic / Line-Plus Inputs are wired unbalanced Left and Right for the cable receiver audio.

A RAD6 provides the stereo input for the internet music service.

A PAGER1 is located at the front desk with scenarios to:

- Page the lounge when a table is ready in the restaurant,
- Page the restaurant when someone is needed at the bar.
- Page the entire restaurant.

The configuration file for this system is available to download at rane.com. See "Small Restaurant and Bar" in Applications.

Build the Halogen configuration for this system yourself, step-by-step. See "Your First Restaurant in Halogen" at rane.com/hal

The National Restaurant Association® provides guidelines for radio, TV and streaming music systems with and without music licensing fees.

Example HAL3s Live Music Venue System

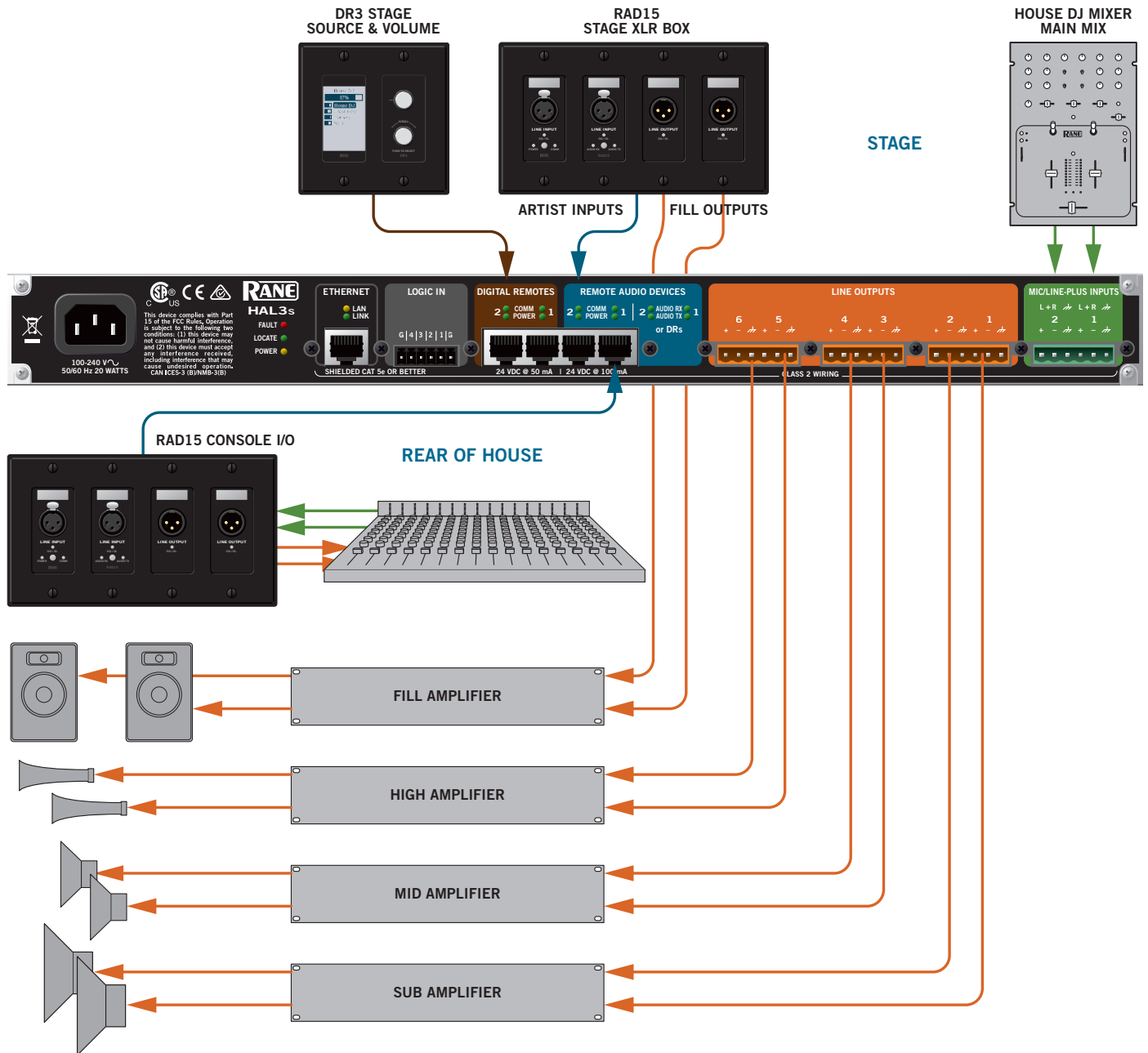

Other Applications

- 5-zone stereo music system
- 10-zone mono music system
- 5-zone mono 2-way (biamped) music system
- 2 room combine system with RADs and remotes in each room.

The configuration file for this system is available to download at rane.com/hal.

Example HAL3s Language Classroom System

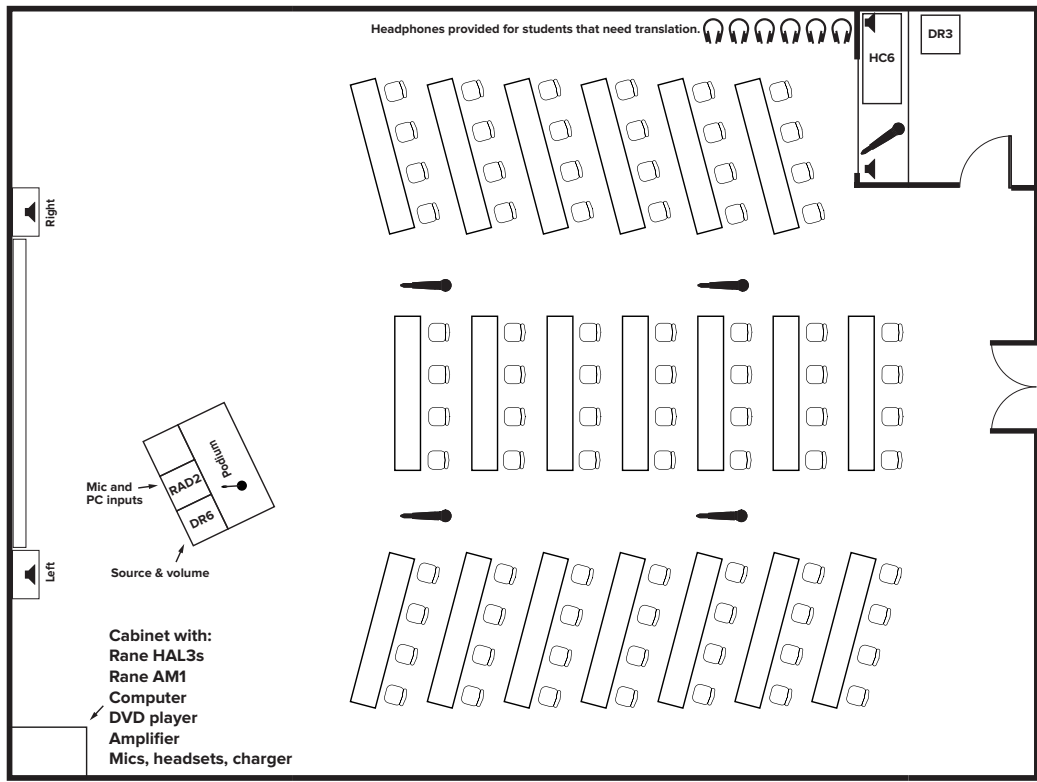
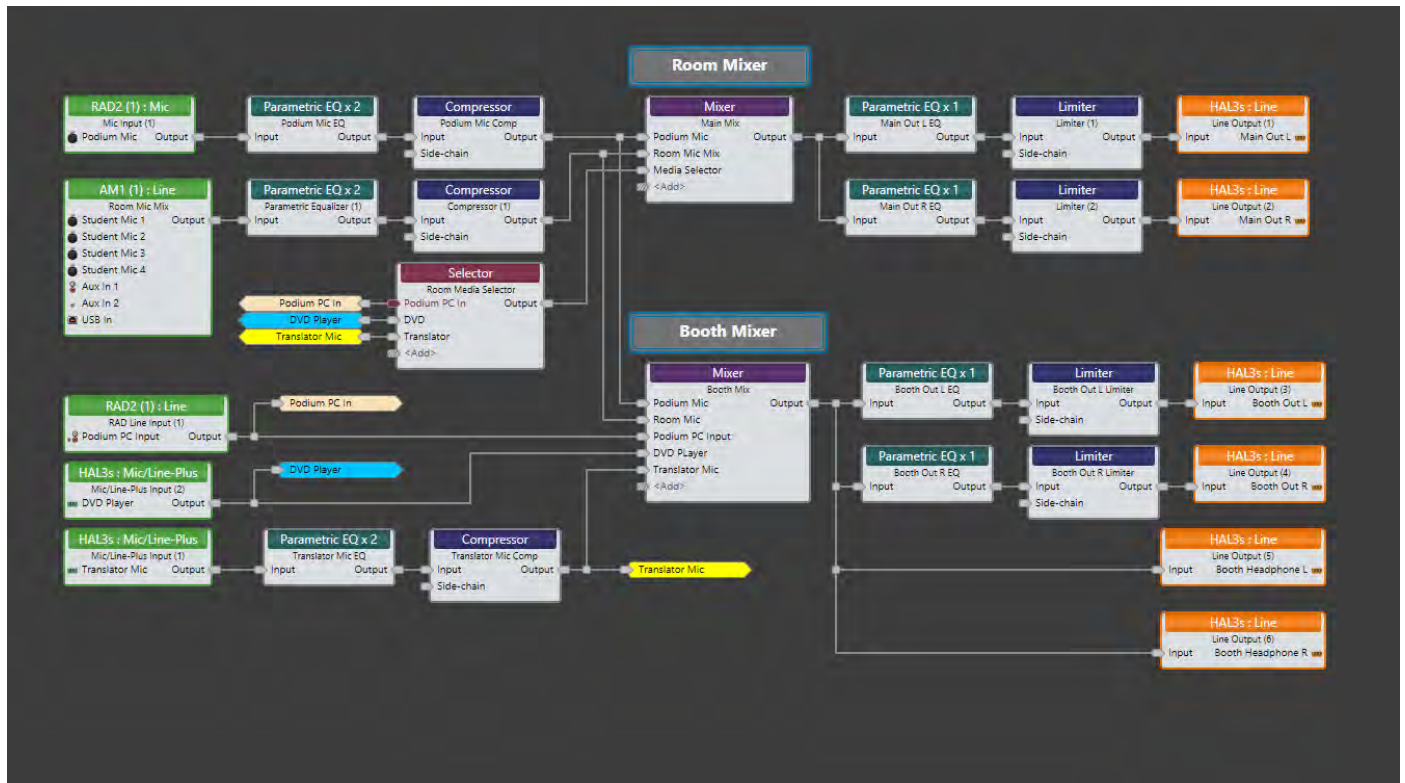

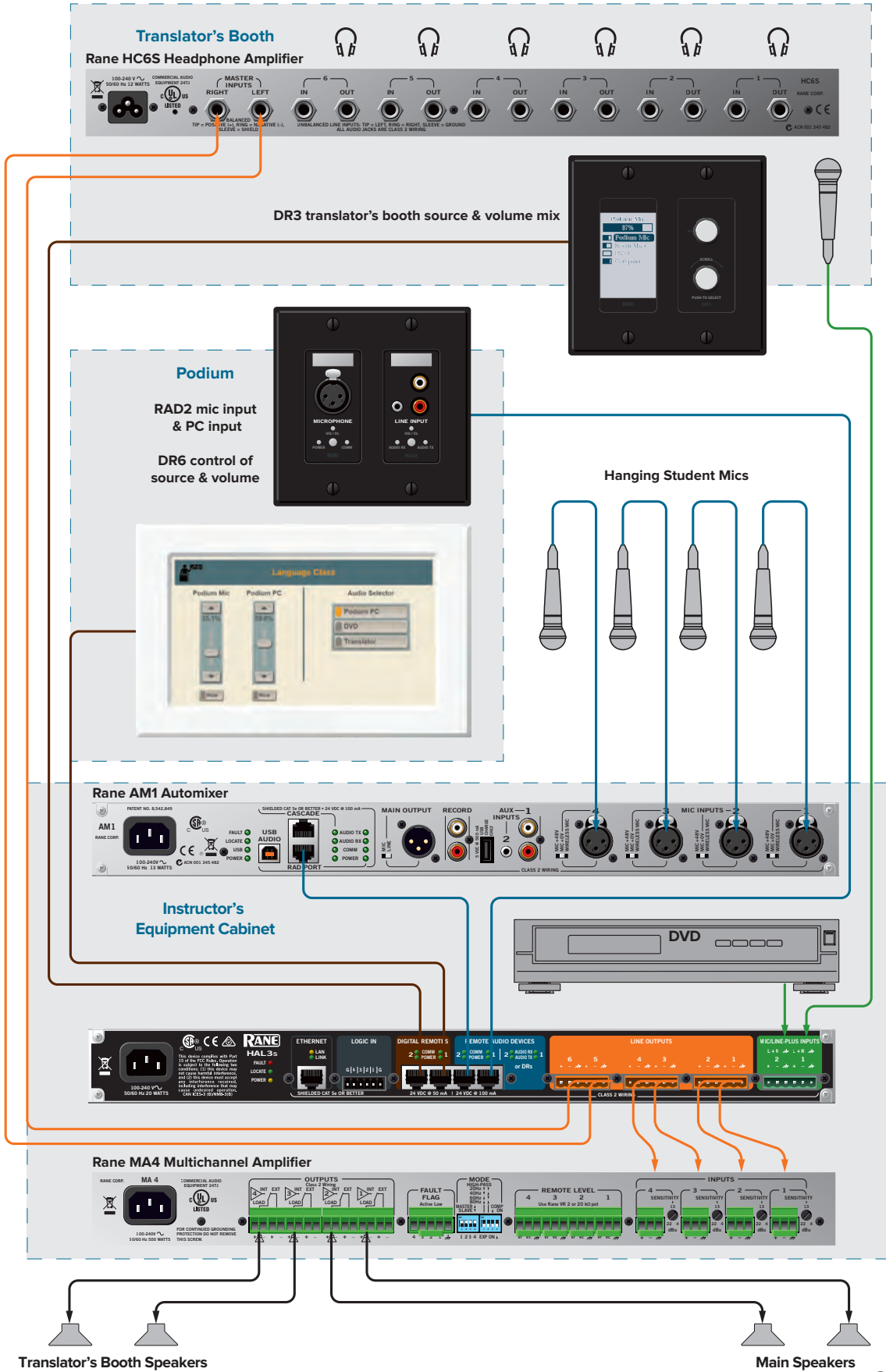

HAL3s Multiprocessor

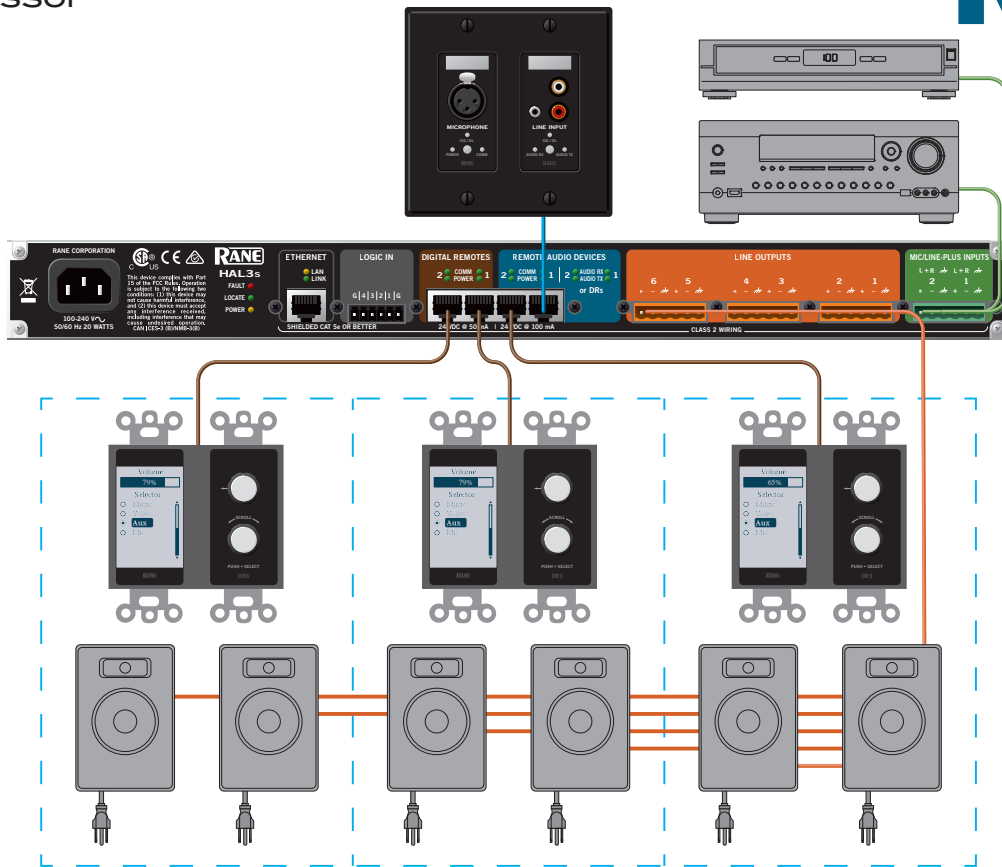

HAL3s Multiprocessor Architects & Engineers Specification

The digital multiprocessor shall be a 6 in x 10 out configuration having six inputs: two mic or line-level analog on a plug-in barrier strip that can be either +4 dBu balanced or -10 dBV unbalanced with left (+) and right (-) automatically monoed; and two digital remote audio device ports providing up to four digital inputs and four digital outputs; as well as six balanced analog line-level outputs on plug-in barrier strips. Phantom power shall be available for a condenser microphone input. Provisions shall be provided for two digital remotes to control source or preset selection, toggle and/or level control located up to 300 meters (1,000 feet) away. In addition there shall be four contact closure logic inputs on a plug-in barrier strip. The remote audio devices shall provide A/D and/or D/A conversion based on AES3 transport to the wall up to 150 meters (500 feet) from the multiprocessor, as well as units for cascable automatic microphone mixing up to 64 channels, control logic expansion and wall sensors, ambient sensing mics, and advanced paging stations. All remote audio devices and digital remotes shall connect via shielded CAT 5e (or better) cable to the multiprocessor. Further, all remote audio devices and digital remote devices shall support portable use and hot swapping so that devices may be replaced without shutting down the system, and do so without any audio interference, and that all settings for new devices are automatically downloaded from the multiprocessor along with the correct firmware. The unit shall connect to a computer using standard Ethernet on an RJ-45 connector. All functions shall be designed, configured and controlled by a software program featuring a graphical user interface that allows managing the global tasks of discovering, connecting to, and applying configurations to the remote digital multiprocessor. The hardware-software combination shall automatically check and display the status, location, CAT 5 crimp and wiring integrity, and that audio is flowing to and/or from all peripheral devices. The hardware multiprocessor and the software shall each include Ethernet ASCII text over TCP/IP control support for third-party control systems such as AMX, Crestron and Stardraw Control, and shall be capable of creating controls accessible from any web browser. The processor shall have an internal 100-240 VAC, 50/60 Hz power supply. *The digital multiprocessor shall be a Rane HAL3s running Rane Halogen software, and using Rane Remote Audio Devices (RADs) and Digital Remotes (DRs).*

Trademarks

- Heuristic Audio Laboratory (HAL)® • HAL and Halogen are trademarks of Rane Corporation • AMX® and the AMX logo are registered trademarks of AMX
- Stardraw Control is a trademark of Stardraw.com Ltd. • Crestron® is a registered trademark of Crestron Electronics, Inc. • Decora® is a registered trademark of Leviton. • Windows® is a registered trademark of Microsoft Corporation in the United States and other countries. • Apple, Mac, Macintosh, iTunes, Safari, QuickTime, GarageBand, and OS X are registered trademarks of Apple Inc., registered in the U.S. and other countries.