



▶▶ NEUMANN.BERLIN

## ▶ KH 810/870

---

ACTIVE SUBWOOFER  
WITH 7.1 HIGH DEFINITION BASS MANAGEMENT™

OPERATING MANUAL







## Contents

<b>Important safety instructions</b> .....	2
<b>The KH 810/870 subwoofer</b> .....	4
Compatibility .....	4
<b>Delivery includes</b> .....	4
<b>Product overview</b> .....	5
<b>Installing and connecting the KH 810/870</b> .....	8
Preparing the subwoofer .....	8
Preparing the room .....	8
Setting up the subwoofers .....	9
Connecting the subwoofer .....	11
<b>Using the KH 810/870</b> .....	17
Switching the subwoofer on/off .....	17
Calibrating the subwoofer .....	17
Compensating for larger time of flight (TOF) differences .....	20
Using the bass management .....	20
Boosting the LFE channel and adjusting the LFE mode .....	20
Activating ground lift .....	22
Remote-controlling the system .....	22
Resetting the settings of the KH 810/870 .....	24
Cleaning and maintaining the subwoofer .....	25
<b>Troubleshooting</b> .....	25
<b>Specifications</b> .....	26
<b>Accessories</b> .....	28
<b>Manufacturer Declarations</b> .....	29
<b>Technical information &amp; glossary</b> .....	30

## Appendix

System block diagram .....	I
Pin assignment of the XLR socket .....	I
Pin assignment of the REMOTE CONTROL AND RS-232 socket .....	I
Acoustical measurements .....	II-IV



## Important safety instructions

1. Read these instructions.
2. Keep these instructions. Always include these instructions when passing the product on to third parties.
3. Heed all warnings.
4. Follow all instructions.
5. Do not use this apparatus near water.
6. Only clean the product when it is not connected to the mains power supply. Clean only with a dry cloth.
7. Always ensure a free air flow through the ventilation openings on the rear of the product. Install in accordance with the manufacturer's instructions.
8. Do not install near any heat sources such as radiators, heat registers, stoves, or other apparatus (including amplifiers) that produce heat.
9. Do not defeat the safety purpose of the polarized or grounding-type plug. A polarized plug has two blades with one wider than the other. A grounding type plug has two blades and a third grounding prong. The wide blade or the third prong are provided for your safety. If the provided plug does not fit into your outlet, consult an electrician for replacement of the obsolete outlet. Always connect to a mains socket outlet with a protective earthing connector.
10. Protect the power cord from being walked on or pinched, particularly at plugs, convenience receptacles, and the point where they exit from the apparatus.
11. Only use attachments/accessories specified by the manufacturer.
12. Use only with the cart, stand, tripod, bracket, or table specified by the manufacturer, or sold with the apparatus. When a cart is used, use caution when moving the cart/apparatus combination to avoid injury from tip-over.
13. Unplug this apparatus during lightning storms or when unused for long periods of time.
14. Refer all servicing to qualified service personnel. Servicing is required when the apparatus has been damaged in any way, such as power supply cord or plug is damaged, liquid has been spilled or objects have fallen into the apparatus, when the apparatus has been exposed to rain or moisture, does not operate normally, or has been dropped.
15. To completely disconnect this apparatus from the AC mains, disconnect the power supply cord plug from the AC receptacle.
16. **WARNING:** To reduce the risk of fire or electric shock, do not expose this apparatus to rain or moisture.
17. Do not expose this equipment to dripping or splashing and ensure that no objects filled with liquids, such as vases, are placed on the equipment.
18. The mains plug of the power supply cord shall remain readily accessible.



### Hazard warnings on the rear of the product

The label shown on the right is attached to the rear of the product.



The symbols on this label have the following meaning:

Presence of uninsulated dangerous voltage within the product's enclosure that may be of sufficient magnitude to constitute a risk of fire or electric shock.



Never open the product or remove the grilles fitted to the product as there is a risk of electric shock. There are no user serviceable parts inside. Refer servicing to your Neumann service partner.



Read and follow the safety and operating instructions contained in the operating manual.





- Installation**
- Ensure that the room in which you use this product is wired in accordance with the local electrical code and checked by a qualified inspector.
  - Only use the product indoors.
  - Do not install the product in hot, humid, or excessively dusty locations, in direct sunlight or in locations where it is exposed to externally generated vibrations.
  - Do not place burning objects (e.g. candles) on top of or near the product.
  - If condensation has formed on the product, e.g. because it was moved from a cold environment to a warm one, allow the product to acclimatize to room temperature before using it.
  - Do not overload wall outlets and extension cables as this may result in fire and electric shock.

**High sound pressure levels**



**WARNING**  
Danger of hearing damage due to sudden high sound pressure levels!

Audio signals that are present at switch-on of the product or that can be present during operation, can create sudden, very high sound pressure levels which can damage your hearing.

- ▶ Always lower the output level of the audio source **before** connecting it to the subwoofer or starting it (pressing “play”).

This subwoofer can be used for commercial purposes. Commercial use is subject to the rules and regulations of the trade association responsible. Neumann, as the manufacturer, is therefore obliged to expressly point out possible health risks arising from use. This subwoofer is capable of producing sound pressure levels exceeding 85 dB(A) SPL. This is the sound pressure corresponding to the maximum permissible level which is by law (in some countries) allowed to affect your hearing for the duration of a working day (8 hours). It is used as a basis according to the specifications of industrial medicine. Higher sound pressure levels and/or longer durations can damage your hearing.

At higher sound pressure levels, the duration must be shortened in order to prevent hearing damage. The following are signs that you have been subjected to excessive sound pressure levels for too long a time.

- You can hear ringing or whistling sounds in your ears.
- You have the impression (even for a short time only) that you can no longer hear high frequencies (temporary threshold shift).

**Magnetic fields**



**WARNING**  
Interference due to magnetic fields!

This product generates stronger permanent magnetic fields that can interfere with cardiac pacemakers and implanted defibrillators (ICDs).

- ▶ Always maintain a distance of at least 4" (10 cm) between the subwoofer and the cardiac pacemaker or implanted defibrillator.

**Intended use**

Intended use of the product includes:

- having read this operating manual, especially the chapter “Important safety instructions”,
- using the product within the operating conditions and limitations described in this operating manual.

“Improper use” means using the product:

- other than as described in this operating manual, or
- under operating conditions which differ from those described herein.

This will invalidate the guarantee.



## The KH 810/870 subwoofer

Thank you for purchasing a Neumann subwoofer. Neumann subwoofers are designed to complement Neumann's extensive range of monitors. They can be used in music, broadcast, and post production studios for tracking, mixing, and mastering. They can be positioned next to a wall or flush mounted into a wall, and can be mixed freely in multi-channel systems with other loudspeakers and subwoofers from the Neumann Studio Monitor Systems range.

The built-in 7.1 Channel High Definition Bass Manager™ is compatible with all formats, from mono to the latest 7.1 High Definition systems. Eight analog channels ensure flexible interconnectivity for modern studios. Four-mode LFE channel processing ensures maximum compatibility across all formats. 4<sup>th</sup> order crossovers and flexible acoustical controls allow for seamless system integration. The built-in volume control allows for centralized system adjustment independent of the source.

The latest high efficiency amplifiers and acoustical components have been used to ensure the most accurate sound reproduction possible. Neumann products are designed for longevity so we hope you enjoy many happy years of using this product.

### Compatibility

The 7.1 Channel High Definition Bass Manager™ is compatible with the following formats:

- 7.1, 7.0 HD (Blu-ray, video gaming)
- 7.1 Theatrical (5 front channels)
- 6.1, 6.0 (DVD, DVD Audio, SACD)
- 5.1, with an additional 2.0 2-channel stereo system
- 5.1, 5.0 (DVD, multi-channel CD, HDTV, video gaming)
- 3/1.0 (LCRS)
- 2.0 (2-channel stereo, reproduced with or without a subwoofer)
- 1.0 (mono)

Larger audio systems can be built using several subwoofers.

### Delivery includes

- 1 KH 810 subwoofer or KH 870 subwoofer
- 3 Mains cables (European, UK and US version)
- 1 Operating manual
- 1 Supplement "Getting Started Quickly"



The current operating manual as well as the supplement "Getting Started Quickly" can also be downloaded from the "Downloads" area on the product page at [www.neumann.com](http://www.neumann.com).



Note that imperial dimensions are approximate.



## Product overview



- ① Neumann logo
- ② Metal grille
- ③ Bass reflex ports

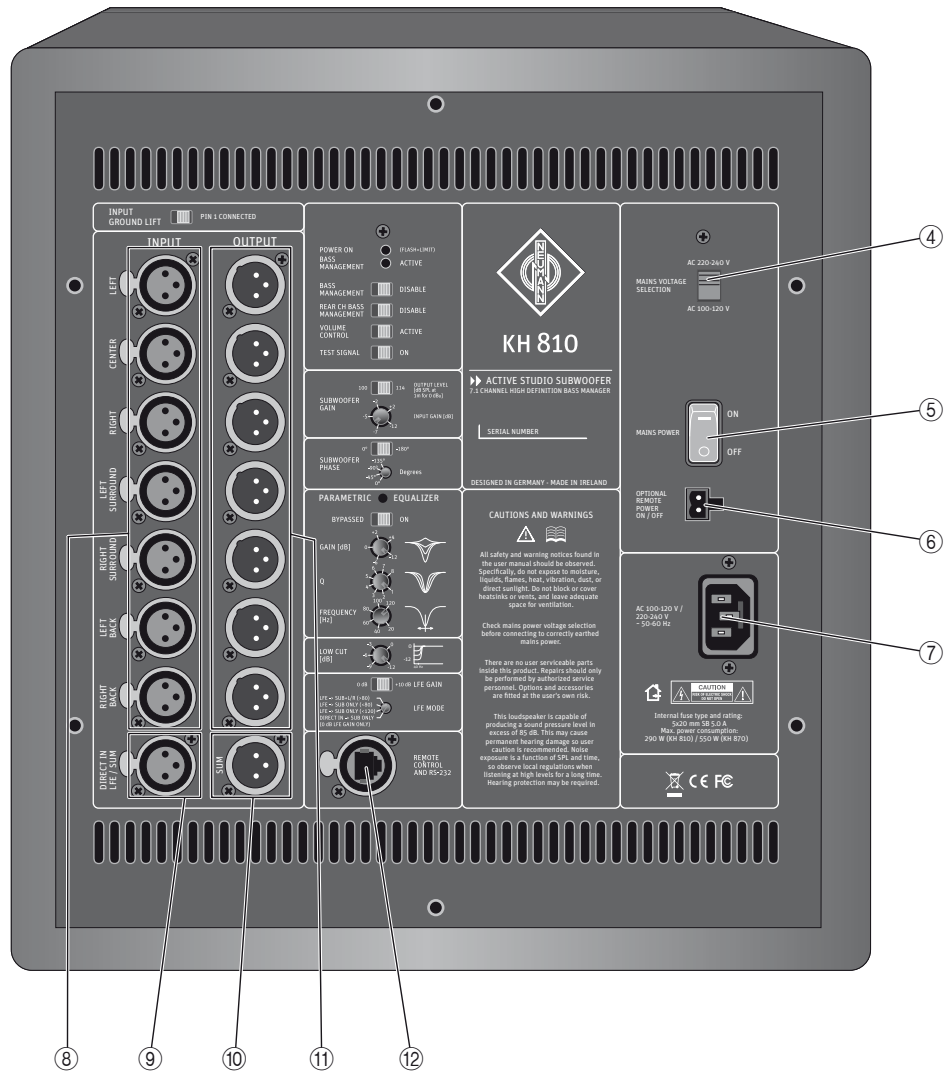

- ④ MAINS VOLTAGE SELECTION switch
- ⑤ MAINS POWER switch
- ⑥ OPTIONAL REMOTE POWER ON/OFF socket
- ⑦ IEC mains socket with protective ground contact
- ⑧ Sockets  
INPUT | LEFT, CENTER, RIGHT  
INPUT | LEFT SURROUND, RIGHT SURROUND  
INPUT | LEFT BACK, RIGHT BACK
- ⑨ INPUT | DIRECT IN / LFE /SUM socket
- ⑩ OUTPUT | SUM socket
- ⑪ Sockets  
OUTPUT | LEFT, CENTER, RIGHT  
OUTPUT | LEFT SURROUND, RIGHT SURROUND  
OUTPUT | LEFT BACK, RIGHT BACK
- ⑫ REMOTE CONTROL AND RS-232 socket



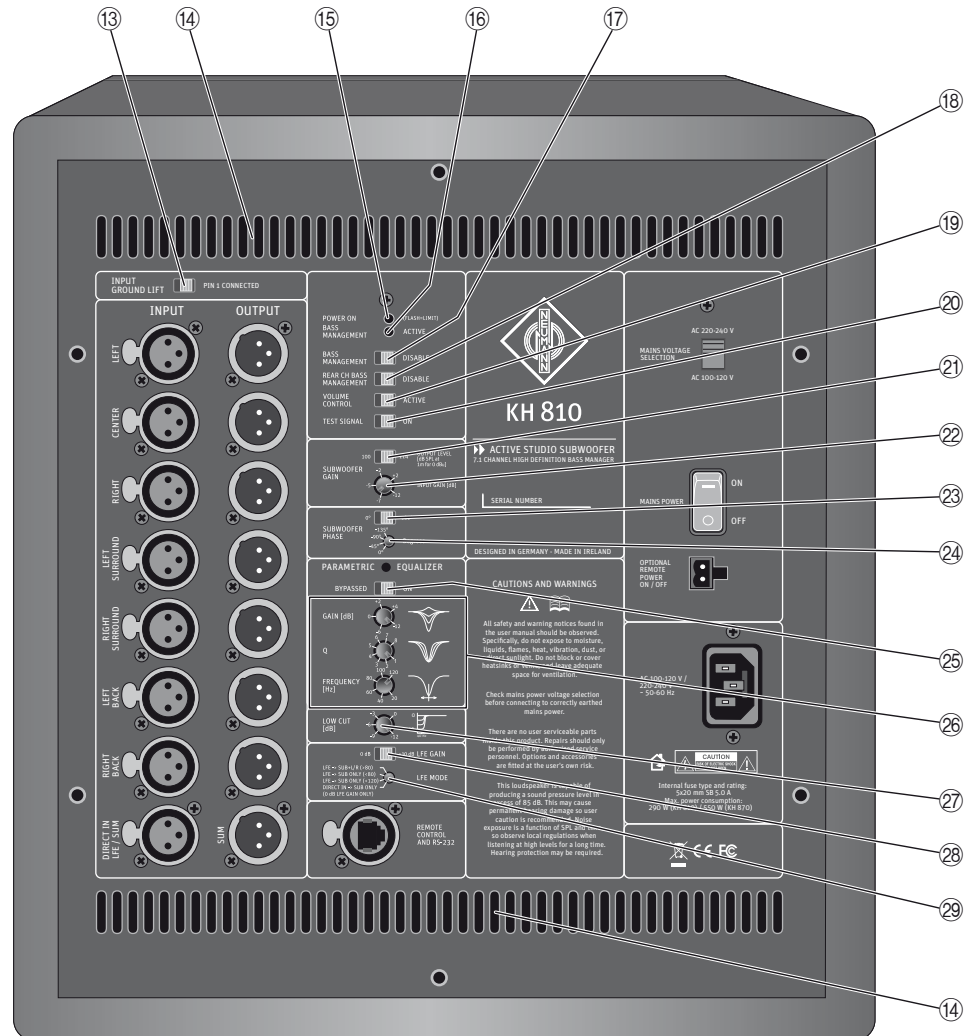

- ⑬ INPUT GROUND LIFT switch
- ⑭ Ventilation openings
- ⑮ POWER ON LED (red)
  - lights up red: subwoofer is switched on and ready for operation
  - flashes red slowly: protection system is active, output level is reduced by 6 dB
  - flashes red rapidly: subwoofer booting-up just after switch-on
  - is off: subwoofer is switched off
- ⑯ BASS MANAGEMENT LED (green)
  - lights up green: bass management activated
  - is off: bass management disabled
- ⑰ BASS MANAGEMENT switch
- ⑱ REAR CH BASS MANAGEMENT switch
- ⑲ VOLUME CONTROL switch
- ⑳ TEST SIGNAL switch
- ㉑ SUBWOOFER GAIN | OUTPUT LEVEL switch
- ㉒ SUBWOOFER GAIN | INPUT GAIN potentiometer
- ㉓ SUBWOOFER PHASE switch
- ㉔ SUBWOOFER PHASE rotary switch
- ㉕ PARAMETRIC EQUALIZER switch
- ㉖ Potentiometers
  - PARAMETRIC EQUALIZER | GAIN
  - PARAMETRIC EQUALIZER | Q
  - PARAMETRIC EQUALIZER | FREQUENCY
- ㉗ LOW CUT potentiometer
- ㉘ LFE GAIN switch
- ㉙ LFE MODE rotary switch

EN



## Installing and connecting the KH 810/870

Have the product installed and connected by a specialist. Due to his/her technical training, know-how and experience as well as knowledge of relevant provisions, regulations and standards, the specialist must be able to assess assigned tasks, recognize potential hazards and ensure appropriate safety measures. The following safety and mounting instructions are addressed to this specialist.



### CAUTION

Danger of injury and material damage due to tipping/dropping of the product!

If improperly mounted, the product and/or the mounting hardware (e.g. rack) can tip over or drop down.

- ▶ Always have the product mounted by a qualified specialist according to local, national and international regulations and standards.
- ▶ Use the mounting systems recommended by Neumann and always provide sufficient additional protection against tipping or dropping by means of safety wires.

### CAUTION

Damage to the product due to overheating!

If air cannot circulate properly through the ventilation openings ⑭ on the rear of the product, the power amplifiers may overheat leading to premature activation of the thermal protection system which limits the maximum output level of the subwoofer. In rare cases, damage to the product may also occur.

- ▶ Never cover the ventilation openings ⑭.
- ▶ When installing the product into tight spaces such as wall recesses, maintain an air gap of at least 2" (5 cm) around the subwoofer's backplate to ensure a free air flow through the ventilation openings.



For information on installation, please refer to the supplied "Getting Started Quickly" supplement. This will help you set up the subwoofers and loudspeakers in a way that will give you the best acoustic performance from the system. For further information on setting up subwoofers and loudspeakers, please refer to the "Questions & Answers" section at [www.neumann.com](http://www.neumann.com).

## Preparing the subwoofer

### CAUTION

Risk of staining surfaces!

Some surfaces treated with varnish, polish or synthetics may suffer from stains when they come into contact with other synthetics. Despite a thorough testing of the synthetics used by us, we cannot rule out the possibility of staining.

- ▶ Do not place the KH 810/870 on delicate surfaces.

The bottom of the subwoofer features rubber feet which reduce the risk of scratching the surface and the subwoofer cabinet, and acoustically isolate the subwoofer from the surface.

If you want to hide the subwoofer:

- ▶ Use a thin open weave cloth. To provide visual cover, you can use two layers of the cloth.

## Preparing the room

- ▶ Arrange all acoustically relevant surfaces and objects symmetrically on either side of the listening axis of the room (left/right).
- ▶ Minimize the sound that is reflected back to the listening position by using angled surfaces and/or acoustical treatment.



This product has been optimized for use in recording studios. In order to avoid affecting the quality of reproduction, make sure that the product is used in an EMC environment.



## Setting up the subwoofers

### Choosing the type of set up

The bass reflex ports are located on the front panel of the subwoofer, allowing the subwoofer to be either set up in a room or flush mounted into a wall recess.

Flush mounting the subwoofer into a wall recess offers the following advantages:

- A solid wall boosts the level of the subwoofer in the room which can be compensated by reducing the output level of the subwoofer. This also reduces distortion resulting in a cleaner sound reproduction.
- Reflections from the wall behind the subwoofer are eliminated so that the frequency response becomes smoother.
- The subwoofer does not occupy space in the room.

If you want to flush mount the subwoofer into a wall recess:

- ▶ Have the wall constructed by an experienced acoustical engineer. At least the following points should be observed:
  - The wall should be solid (stone, brick, concrete, several layers of gypsum or MDF).
  - Ensure a free air flow through the ventilation openings ⑭ on the rear of the subwoofer (see warning note on page 8) or remote locate the subwoofer electronics using the Neumann REK 3 remote electronics kit and an SC cable (available in different lengths, see “Accessories” on page 28).

### Using one or several subwoofers

▶ Use ...

one subwoofer	several subwoofers
... if your room does not offer sufficient space for several subwoofers.	... if you need to move left and right along the mixing console, or if there are several listening positions along a large format mixing console.
... if you prefer an easier installation of your system.	... if you require a higher output power or less distortion with the same output power.
	... to suppress lateral modes or cross modes in the room by means of a Plane Wave Bass Array (PWBA™).
	... if many smaller cabinets are easier to position than one large cabinet.

**i** To reduce low-frequency distortion, the uncalibrated output level of your subwoofer should always be higher than the output level of your loudspeakers. We recommend using arrays with several subwoofers, in which case the uncalibrated maximum output level of the subwoofer array should also be higher than the maximum output level of all the loudspeakers in the system. The subwoofers can then be calibrated to a lower output level resulting in lower distortion and correspondingly cleaner low-frequency reproduction.

For information on building a balanced system, please refer to the “Product Selection Guide” at [www.neumann.com](http://www.neumann.com).

### Positioning the subwoofers

Regardless of whether you are setting up one or several subwoofers:

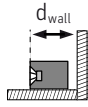

- ▶ Always ensure that the distance  $d_{wall}$  between the wall behind the subwoofer and the subwoofer's front is less than 0.8 m.

If you are setting up **one** subwoofer:

- ▶ Position the subwoofer against the front wall, slightly left or right of the middle of the front wall and between the left and right loudspeakers.

If you are setting up **several** subwoofers as a Plane Wave Bass Array™ (PWBA™):

- ▶ Use two to four subwoofers for smaller rooms and three to four subwoofers for larger rooms.
- ▶ Set up the subwoofers along the front wall within half a wavelength of each other. The maximum spacing of the subwoofer cabinets is determined by the setting of the LFE mode (see page 20):

Setting	Max. spacing of the subwoofer cabinets
LFE → SUB + L/R (>80)	approx. 2 m (6'6")
LFE → SUB ONLY (<80)	approx. 2 m (6'6")
LFE → SUB ONLY (<120)	approx. 1.4 m (4'6")
DIRECT IN → SUB ONLY	approx. 1.4 m (4'6")

If you observe the stated spacing, the subwoofers form a cylindrical source and generate a plane wave down the room, a so-called Plane Wave Bass Array™ (PWBA™). The PWBA™ reduces stationary waves between the side walls, improves the bass reproduction and suppresses lateral room resonances.

- i For examples of set up positions and distances, please refer to the supplied "Getting Started Quickly" supplement.

You can correct excessive low frequency energy in the room using the potentiometer SUBWOOFER GAIN | INPUT GAIN ② and the switch SUBWOOFER GAIN | OUTPUT LEVEL ① (cf. page 31).

### Utilizing the acoustical gain

If you set up several subwoofers, you can utilize their mutual coupling to achieve an acoustical gain. The following acoustical gains are possible:

Number of subwoofers	Acoustical gain
1	0.0 dB
2	6.0 dB
3	9.5 dB
4	12.0 dB

### Positioning and orienting subwoofers and loudspeakers

Subwoofers are omni-directional in their typical pass band as the generated wavelength is long compared to the surface producing the sound, therefore it does not matter in which direction the subwoofer is oriented when placed in the listening environment.



For your loudspeakers, however, an accurate positioning and orientation is vital.

- ▶ Position your loudspeakers as follows:

System	Position and orientation
2.0 (stereo)	±30°
5.1	ITU-R BS.775-1: 0°, ±30°, ±110° (±10°) (center, front left/right, surround left/right)
	ANSI/SMPTE 202M: 0°, ±22.5°, arrays to the surround left and to the surround right, plus optional subwoofer(s)
6.1	as 5.1 systems plus 180° (back center)
7.1	0°, ±30°, ±90°, ±150° (center, front left/right, side left/right, back left/right)

For detailed information on the positioning and orientation of your loudspeakers, please refer to the operating manuals of the loudspeakers.

If your subwoofers cannot be placed at the same distance from the listening position as the loudspeakers, time-of-flight differences will occur.

- ▶ Avoid distance differences of > 2 m (6'6").
- ▶ Compensate for time-of-flight differences as described in the chapter “Calibrating the phase” on page 19.

## Connecting the subwoofer

### Connecting the subwoofer to an audio source

- ▶ Use balanced XLR cables to connect the corresponding sockets INPUT ⑧ of the KH 810/870 to the audio source.

#### Connecting unbalanced cables

- ▶ Use an XLR adapter (not supplied) to connect unbalanced cables (e.g. RCA cables). Use the following wiring if you want to make your own XLR adapter:

Wiring	Pin	Signal
	1	Audio ground
	2	Signal +
	3	Signal –

The level delivered by devices with RCA outputs (–10 dBV) is usually less than the studio level (+4 dBu):

- ▶ If necessary, use active unbalanced-to-balanced converters in order to be able to connect devices with unbalanced signals.



### Connecting loudspeakers to the subwoofer

For a simplified representation, the following connection examples show small loudspeakers in combination with the KH 810 subwoofer. Each of the examples only shows one possible combination of loudspeakers and subwoofers. For information on building a balanced system, please refer to the “Product Selection Guide” at [www.neumann.com](http://www.neumann.com). In addition, the subwoofer electronics are shown separately from the KH 810 to provide better clarity.

- Use balanced XLR cables to connect the corresponding sockets OUTPUT ⑪ of the subwoofer to the input sockets of the loudspeakers, as shown in the following diagrams.

Connection of a 7.1 system

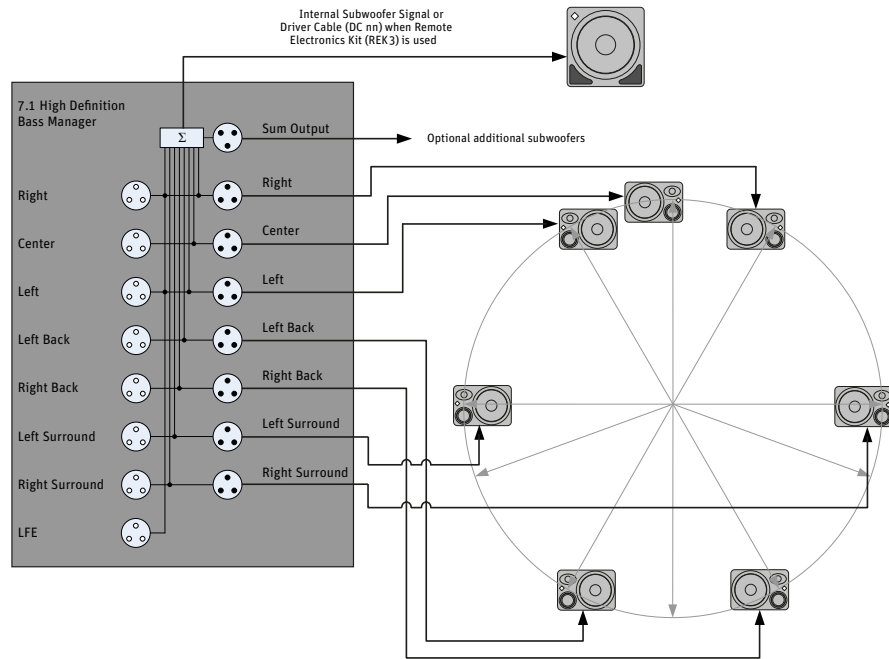

The diagram “Connection of a 7.1 system” also demonstrates that the built-in 7.1 Channel High Definition Bass Manager™ can be used to build 1.0, 2.0, 3/1.0, 5.0, 5.1, 6.0, 6.1 and 7.1 Theatrical systems.

Simultaneous connections of 5.1 and 2.0 signals

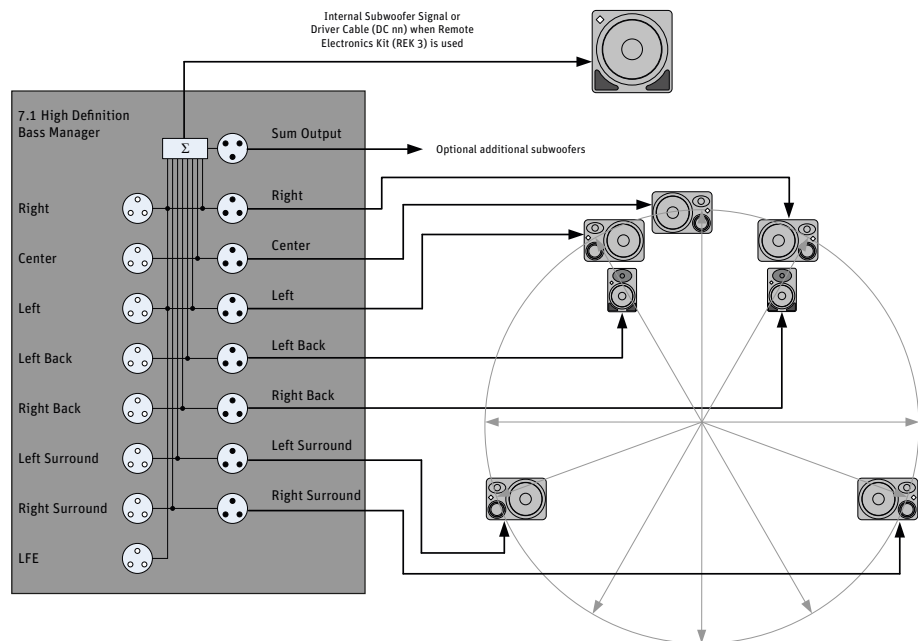



The diagram “Simultaneous connections of 5.1 and 2.0 signals” shows the possibility of an additional bass extension for a 2.0 signal:

- ▶ First, set up a 5.1 system.
- ▶ Connect a stereo signal to the unused sockets INPUT | LEFT BACK and RIGHT BACK ⑧.
- ▶ Connect an additional pair of loudspeakers to the unused sockets OUTPUT | LEFT BACK and RIGHT BACK ⑪.  
You now have a separate 2.0 system that can use the subwoofer.
- ▶ Send **either** a 5.1 or a 2.0 signal to the system.
- ▶ Try to keep the two pairs of loudspeakers connected to the sockets INPUT | LEFT/INPUT | LEFT BACK and INPUT | RIGHT/INPUT | RIGHT BACK at the same distance from the listening position (see diagram) so that different phase settings are not required.

### Connecting several KH 810/870

To increase the number of subwoofers in a system and to make a Plane Wave Bass Array™, you can connect the KH 810/870 to additional KH 810/870 subwoofers. In such a set-up, the input signals are only connected to the first subwoofer in the chain. The LFE mode and bass management is defined in the first subwoofer.

- ▶ Connect your audio source to the sockets INPUT | LEFT/RIGHT BACK, LEFT/RIGHT SURROUND, LEFT, CENTER and RIGHT ⑧ and to the socket INPUT | DIRECT IN / LFE / SUM ⑨ of the first subwoofer.
- ▶ Connect the socket OUTPUT | SUM ⑩ to the analog input socket INPUT | DIRECT IN / LFE / SUM ⑨ of another KH 810/870 subwoofer.
- ▶ Set the rotary switch LFE MODE ⑳ of all additional subwoofers to “DIRECT IN -> SUB ONLY”. This prevents double filtering of the audio signal.
- ▶ Make sure that all other settings such as level, phase, EQ, ... are also set on each of the additional subwoofers. This information is not daisy-chained from the first subwoofer (master) to the additional subwoofers.

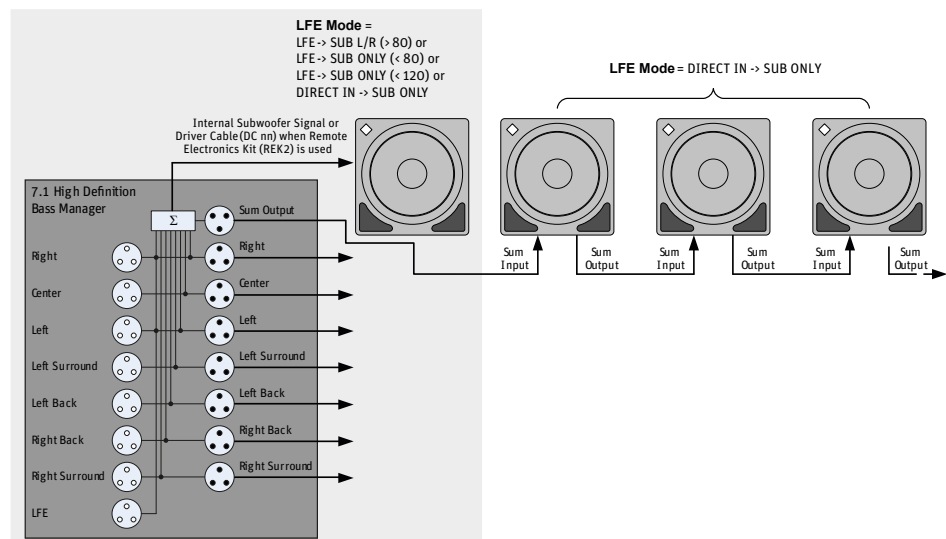

### Using subwoofers in a 4-way system

To build a larger system:

- ▶ Install the subwoofers and loudspeakers like columns:

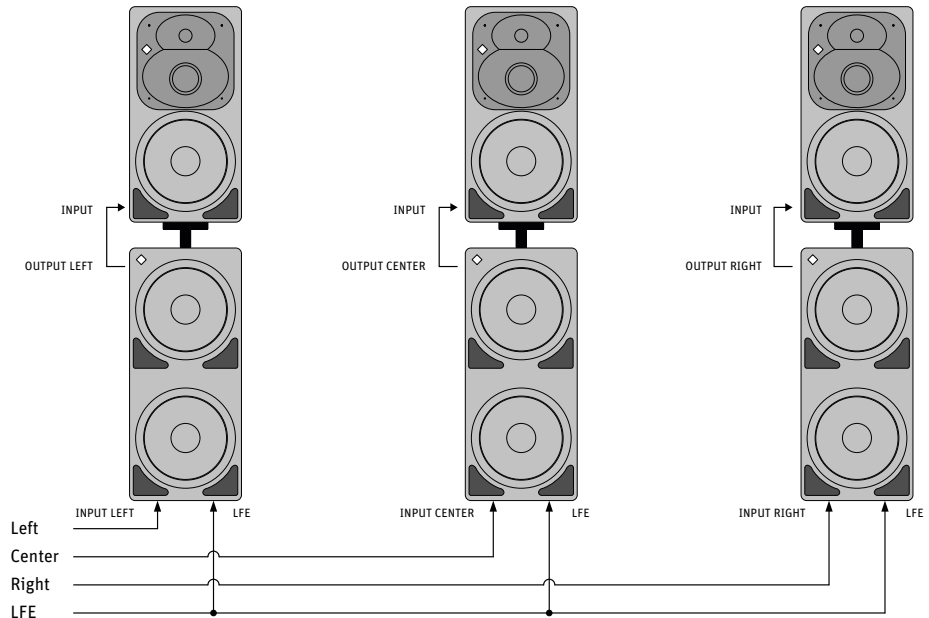

- ▶ Connect the channels Left, Center, Right of your audio source to the subwoofers according to their physical position (see diagram above):
  - Connect the channel Left to the socket INPUT | LEFT ⑧ of the left subwoofer, connect the channel Center to the socket INPUT | CENTER ⑧ of the middle subwoofer and connect the channel Right to the socket INPUT | RIGHT ⑧ of the right subwoofer.
- ▶ Use a Y-cable (not supplied) to connect the LFE channel of the audio source to the sockets INPUT | DIRECT IN / LFE /SUM ⑨ of all three subwoofers.

**i** To tilt the loudspeakers, you can use Neumann mounting hardware such as, for example, the LH 36.

The subwoofers should be acoustically calibrated so that they smoothly extend the bass response of their respective main loudspeaker. As three subwoofers are being used to reproduce one signal, there is a 9.5 dB acoustical boost for the LFE channel only. The LFE channel level should be adjusted at the audio source by  $-9.5$  dB or  $+0.5$  dB so that the reproduction level (0 or  $+10$  dB) is consistent with the main channels.



### Connecting/disconnecting the subwoofer to/from the mains power supply

To connect the KH 810/870 to the mains power supply:

- ▶ Make sure that the switch MAINS POWER ⑤ is set to “OFF”.
- ▶ Make sure that the switch MAINS VOLTAGE SELECTION ④ is set to the correct position:
  - “AC 100/120 V” if your mains voltage is 100 V or 120 V or
  - “AC 220/240 V” if your mains voltage is 220 V, 230 V or 240 V.
- ▶ If necessary, carry out further steps for a remote switch-on/switch-off (see below).
- ▶ Connect the IEC connector of the supplied mains cable to the IEC mains socket ⑦.

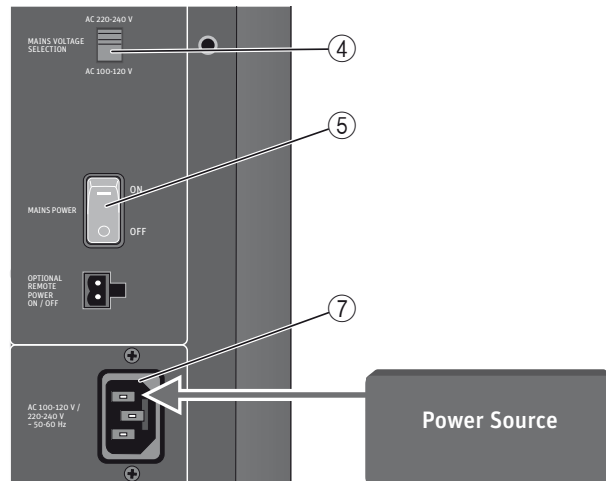

- ▶ Connect the mains plug of the mains cable to a suitable wall socket.

To disconnect the KH 810/870 from the mains power supply:

- ▶ Set the switch MAINS POWER ⑤ to “OFF”.
- ▶ Pull the mains plug out of the wall socket.

### Mounting the subwoofer electronics externally

If you distribute the subwoofers around the room but wish to have centralized access to the operating controls of the subwoofer electronics or if you set up your subwoofers so that easy access to the subwoofer electronics is not possible, you can mount the latter externally:

- ▶ Use the Neumann REK 3 remote electronics kit together with an SC cable (available in different lengths, see “Accessories” on page 28).
- ▶ Proceed as described in the operating manual of the REK 3.

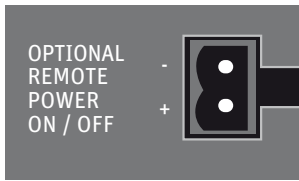

### Preparing the subwoofer for remote on/off switching

- ▶ Have your Neumann service partner enable the remote on/off switching function inside the subwoofer.
- ▶ Use a Euroblock connector (not supplied) to connect a two-core cable (12 V DC) to the socket OPTIONAL REMOTE POWER ON/OFF ⑥ (socket pin assignment shown on the left).

 For further information on remotely switching the subwoofer on/off, please refer to page 17.

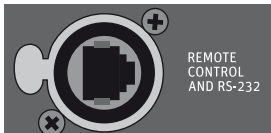

### Preparing the subwoofer for remote control/RS-232 control

#### CAUTION

Material damage due to improper use of cables!

If you insert a network cable that is connected to the KH 810/870 into a network socket, the network device can be damaged. If network signals are transmitted to the KH 810/870 via a network cable, the KH 810/870 can be damaged.

- ▶ Only connect the KH 810/870 to Neumann remote controls or devices that deliver a RS-232 signal using a high-quality Neumann RC CAT5 cable (see below). Do not use a “crossover” type of CAT5 cable.

You can remote control the KH 810/870 via the Neumann NRC 1 remote control (see “Accessories” on page 28) or control it via an RS-232 signal. For more information, please refer to the operating manuals of the remote controls and to page 22.

- ▶ Connect the NRC 1 remote control or the RS-232 control to the socket REMOTE CONTROL AND RS-232 ⑫. Use Neumann RC cables with Neutrik EtherCon connectors (see “Accessories” on page 28). These cables are available in different lengths, have been designed for heavy-duty use and provide maximum freedom of movement.

 The pin assignment of the socket REMOTE CONTROL AND RS-232 ⑫ can be found at the end of this operating manual.

To remote control more than one subwoofer, an SEA 1 is required (see “Accessories” on page 28). This device duplicates control signals across multiple subwoofers. For more information, see the SEA 1 operating manual.

## Using the KH 810/870

### Switching the subwoofer on/off

You can switch the KH 810/870 on and off using the switch MAINS POWER ⑤ or remotely.

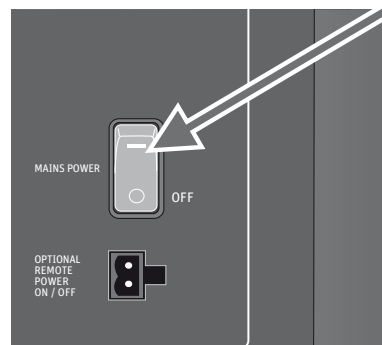

On/off switching using the switch MAINS POWER ⑤

- ▶ Set the switch MAINS POWER ⑤ to:
  - “ON” to switch the subwoofer on. The LED POWER ON ⑬ flashes for 3 seconds, during which the subwoofer is muted (see below). The LED POWER ON ⑬ then lights up red.
  - “OFF” to switch the subwoofer off. The LED POWER ON ⑬ goes off.

**i** There is a three second delay before sound can be heard from the KH 810/870 in order to avoid noises (pops) from preceding equipment switched on at the same time. Conversely, switching off the subwoofer immediately mutes the audio.

Remote on/off switching

- ▶ Carry out all steps described in the chapter “Preparing the subwoofer for remote on/off switching” on page 16.
- ▶ Make sure that the switch MAINS POWER ⑤ is set to “ON”.
- ▶ Apply 12 V DC to remotely switch the subwoofer electronics on or apply 0 V DC to remotely switch the subwoofer electronics off.

### Calibrating the subwoofer

Before using your system for the first time and whenever you change the physical conditions in your studio, carry out the following steps:

- ▶ Adjust the frequency response and the level of the loudspeakers **before** calibrating the subwoofer (see the operating manual of the loudspeakers):

Application	Recommended frequency response	Commentary
Studio	flat	–
Film	X-curve shape	Cf. ANSI/SMPTE 202M: the shape of the X-curve depends on the size of the room
Home	subjective evaluation	Not necessarily a flat response, a gently downward sloping response with increasing frequency is often preferred

All the loudspeakers in the system should have the same level at the listening position. This is often measured using a pink noise test signal that is set to –18 dBFS (Europe) or –20 dBFS (USA) on the mixing console’s output level meters and a sound level meter set to “C-weighted” and “slow”.



▶ Calibrate the frequency response, the phase and the acoustical level of the subwoofer. To do so, choose one of the following methods:

1. Calibration using an acoustical measurement system  
Calibrating the frequency response, phase and sound pressure level by means of an acoustical measurement system should always be your first choice since it yields the highest accuracy. This method is described below.
2. Calibration using Neumann test signals  
In the absence of an acoustical measurement system, you can calibrate the settings of your subwoofer using Neumann test signals (see page 19).
3. Calibration using music signals and an 80 Hz test signal  
A calibration by means of music signals is also possible but should always be the last choice. In this case, use the built-in 80 Hz test signal generator to calibrate the phase (see page 19).

If you are using several subwoofers, it is possible that the same setting is not valid for all subwoofers.

- ▶ Calibrate each subwoofer separately.
- ▶ If necessary, move the subwoofer and/or the main loudspeakers.
- ▶ If necessary, apply acoustical treatment to the source of any reflections.

### Calibration using an acoustical measurement system

**i** The settings of the potentiometer SUBWOOFER GAIN | INPUT GAIN 22 recommended in the following table are valid for the following settings of your Neumann loudspeaker: INPUT GAIN: “0 dB” and OUTPUT LEVEL: “100 dB SPL at 1 m for 0 dBu”. For information on how to set your Neumann loudspeaker, please refer to its operating manual. If the mentioned values cannot be set on your loudspeaker, adjust the subwoofer accordingly.

Calibrating the frequency response

The frequency response of a subwoofer depends on its position in the room and on the room geometry. The same subwoofer installed in different positions in the same room may require different acoustical control settings.

▶ Adjust the frequency response of the subwoofer at your listening position. To do so, proceed as follows:

- ▶ Make sure that the switch SUBWOOFER GAIN | OUTPUT LEVEL 21 is set to “100 dB SPL at 1 m for 0 dBu”.
- ▶ First, set the potentiometers SUBWOOFER GAIN | INPUT GAIN 22 and LOW CUT 27 to the following settings. These settings can be used as a starting point for further adjustment:

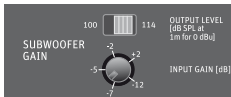

Subwoofer position	Setting of potentiometer SUBWOOFER GAIN   INPUT GAIN 22	Setting of potentiometer LOW CUT 27
In a corner	-8 dB	-4 dB
Next to or flush mounted in an acoustically solid wall (e.g. brick, concrete)	-4 dB	-2 dB
Next to or flush mounted in an acoustically soft wall (e.g. gypsum)	-2 dB	0 dB
Free standing in an untreated room	-2 dB	0 dB
Free standing in a well-treated room	0 dB	0 dB

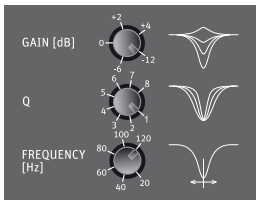

- ▶ Check the frequency response at the listening position using your acoustical measurement system:
  - In case of acoustical loading in the low frequency range at the listening position, turn the potentiometer LOW CUT 27 to the left. This reduces the output level of the subwoofer towards lower frequencies.
  - Use the parametric equalizer 26 to compensate for further nonlinearities in the frequency response below 120 Hz caused by room modes.

Calibrating the subwoofer level

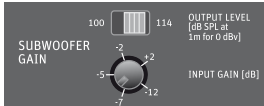

- ▶ Measure the subwoofer's sound pressure level at the listening position.
- ▶ Adjust the sound pressure level of the subwoofer so that the level of the frequency response of the subwoofer below 80 Hz corresponds to the level of the frequency response of the loudspeakers above 80 Hz.
  - To do so, use the potentiometer SUBWOOFER GAIN | INPUT GAIN 22 and the switch SUBWOOFER GAIN | OUTPUT LEVEL 21. Make sure that the input signal is not too high.

Calibrating the phase

- ▶ Set the phase using the rotary switch SUBWOOFER PHASE 24. Values from  $-180^\circ$  to  $-315^\circ$  can be obtained by setting the switch SUBWOOFER PHASE 23 to  $-180^\circ$  and by adding the set value of the rotary switch SUBWOOFER PHASE 24.
 

**Example:** To obtain a phase shift of  $-270^\circ$ , set the switch SUBWOOFER PHASE 23 to  $-180^\circ$  and the rotary switch SUBWOOFER PHASE 24 to  $-90^\circ$
- ▶ Set the rotary switch SUBWOOFER PHASE 24 in combination with the switch SUBWOOFER PHASE 23 to values of  $0^\circ$ ,  $-45^\circ$ ,  $-90^\circ$ ,  $-135^\circ$ ,  $-180^\circ$ ,  $-225^\circ$ ,  $-270^\circ$ , and  $-315^\circ$ , until you have found the setting that gives the lowest sound pressure level at the listening position at the cut-off frequency of 80 Hz (180° phase shift between subwoofer and loudspeaker, maximum level cancelation).
- ▶ Set the switch SUBWOOFER PHASE to the opposite position. The phase shift between loudspeaker and subwoofer is now  $0^\circ$ . Check your subwoofer's sound pressure level again and, if necessary, readjust it so that it corresponds to the sound pressure level of the loudspeakers.
 

Your system is now completely acoustically calibrated.

Calibration using Neumann test signals

- ▶ Download the Neumann test signals and the instructions for use (PDF file, in English) from the KH 810/870 product page at [www.neumann.com](http://www.neumann.com).
- ▶ Follow the steps described there.

Calibration using music signals and an 80 Hz test signal

- ▶ Adjust the settings for the sound pressure level and the frequency response as described above.
- ▶ Calibrate the acoustical phase using the built-in 80 Hz test signal generator. Check the settings of the sound pressure level and frequency response by means of music signals you are familiar with.
  - Connect the left front loudspeaker to the socket OUTPUT | LEFT 11.
  - Set the switch BASS MANAGEMENT 17 to "BASS MANAGEMENT".
  - Set the switch TEST SIGNAL 20 to "ON".
 

An 80 Hz test signal is internally applied to the audio input INPUT | LEFT 8 and is reproduced at the socket OUTPUT | LEFT 11 and by the subwoofer.
  - Set the rotary switch SUBWOOFER PHASE 24 in combination with the switch SUBWOOFER PHASE 23 to values of  $0^\circ$ ,  $-45^\circ$ ,  $-90^\circ$ ,  $-135^\circ$ ,  $-180^\circ$ ,  $-225^\circ$ ,  $-270^\circ$ , and  $-315^\circ$ , until you have found the setting that gives the lowest sound pressure level at the listening position at the cut-off frequency of 80 Hz (180° phase shift between subwoofer and loudspeaker, maximum level cancelation).
  - Set the switch TEST SIGNAL 20 to "OFF".
  - Set the switch SUBWOOFER PHASE 23 to the opposite position.
 

The phase shift between loudspeaker and subwoofer is now  $0^\circ$ .





- ▶ Check the settings of the sound pressure level and frequency response by means of music signals. Listen for a smooth extension of the frequency response of the main loudspeakers down to 20 Hz.

To to this, proceed as follows:

- ▶ Listen to music containing content down to 20 Hz. Activate and disable the bass management by repeatedly moving the switch BASS MANAGEMENT ⑰ between the two positions. There should be no increase or decrease in level below 80 Hz.

### Compensating for larger time of flight (TOF) differences

If the subwoofer is placed at a distance > 2 m (6'6") behind the loudspeakers with reference to the listening position, the subwoofer's integrated compensation settings will not suffice.

Compensating for TOF differences by means of an electronic time delay

- ▶ Connect the KH 810/870 to an electronic time delay. Insert the electronic time delay into the signal path between the sockets OUTPUT ⑩ of the subwoofer and the input sockets of the loudspeakers.
- ▶ Compensate for TOF differences using the electronic time delay (see the operating instructions of the delay).

### Using the bass management



- ▶ Set the switch BASS MANAGEMENT ⑰ to "BASS MANAGEMENT". The bass management is activated. This inserts a 4<sup>th</sup> order 80 Hz high pass filter into the signal path of the audio outputs OUTPUT | LEFT, CENTER, RIGHT, LEFT/RIGHT SURROUND and LEFT/RIGHT BACK and routes all audio signals below 80 Hz to the subwoofer. The LED BASS MANAGEMENT ⑰ lights up green.

To exclude the audio channels OUTPUT | LEFT/RIGHT BACK and OUTPUT | LEFT/RIGHT SURROUND from the bass management:

- ▶ Set the switch REAR CH BASS MANAGEMENT ⑱ to "DISABLE".

**i** If you set the switch BASS MANAGEMENT ⑰ to "DISABLE", this also deactivates the bass management of the audio outputs OUTPUT | LEFT/RIGHT BACK.

If you deactivate the bass management, the audio signal of the audio outputs OUTPUT | LEFT, CENTER, RIGHT, LEFT/RIGHT SURROUND and LEFT/RIGHT BACK is only reproduced by the loudspeakers, while the subwoofer only reproduces the signal of the LFE channel. Use this function to prevent the low frequency signal components of the main channels being reproduced by the subwoofer.

- ▶ Set the switch BASS MANAGEMENT ⑰ to "DISABLE".

### Boosting the LFE channel and adjusting the LFE mode

**i** If you are using three subwoofers in a 4-way system (see page 14), the acoustical level of the LFE signal is boosted by 9.5 dB. In this case, it is sufficient to increase the level of the audio source by 0.5 dB to obtain an LFE gain of 10 dB.

Using the LFE 10 dB gain

You can boost the level of the LFE channel by 10 dB. This boost can be performed in the monitoring matrix (console or external), in a decoder output stage (surround sound processor or DVD/Blu-ray disk player), or in the 7.1 High Definition Bass Management System of the KH 810/870.

- ▶ First, check if a 10 dB gain has already been applied somewhere else in the signal path.

If this is the case:

- ▶ Make sure that the switch LFE GAIN ⑳ is set to "0 dB".



If the boost of the LFE channel is to be performed in the 7.1 Channel High Definition Bass Management System of your subwoofer:

- Make sure that the rotary switch LFE MODE ⑳ is not set to “DIRECT IN -> SUB ONLY”. Set the switch LFE GAIN ㉘ to “+ 10 dB”.

**Adjusting the LFE mode**



The following settings only apply to the audio input INPUT | DIRECT IN / LFE /SUM ㉑.

- Set the rotary switch LFE MODE ⑳ to the desired position:

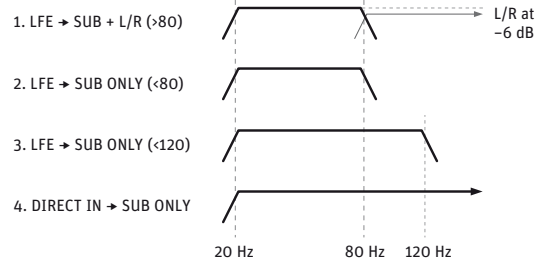
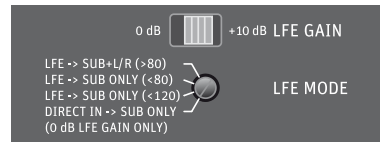

Setting	Behavior of the subwoofer
LFE → SUB + L/R (> 80)	Up to 80 Hz, the LFE channel is reproduced by the subwoofer. Above 80 Hz, the LFE channel is routed to the audio outputs OUTPUT   LEFT and RIGHT.  To compensate for a 6 dB acoustical gain when reproducing the signal via the audio outputs OUTPUT   LEFT and RIGHT, a 6 dB electrical attenuation is applied. This mode works with all formats and is consistent with the standard downmix coefficients seen in consumer decoders.  Additionally, this mode is useful for detecting higher frequency signals in the LFE channel that should be avoided during mixing.
LFE → SUB ONLY (< 80)	The LFE channel is reproduced up to 80 Hz in the subwoofer only. This setting comes from a recommendation by Dolby and THX to “pre-filter” the LFE channel and is used to simulate consumer decoders that do not reproduce the upper part of the LFE bandwidth.
LFE → SUB ONLY (< 120)	The LFE channel is reproduced up to 120 Hz in the subwoofer only. This is the norm for the movie industry. Please note that, during mixing, unwanted higher frequency signal components (above 120 Hz) in the LFE channel are not reproduced by the subwoofer.
DIRECT IN → SUB ONLY	The LFE channel is reproduced by the subwoofer only. There is no filtering of the LFE channel. Select this setting if you want to daisy-chain additional subwoofers (see page 13) and if an external bass management is used (e.g. surround sound processors or DVD/Blu-ray disk players; the output is often labeled “Subwoofer”).  Additionally, this mode is useful for detecting higher frequency signal components (up to 300 Hz) in the LFE channel that should be avoided during mixing.  Please note that the LFE gain is always 0 dB in this mode.



## Activating ground lift

If there is humming or buzzing noise coming from the subwoofer, first search for the cause of the noise:

- ▶ Disconnect all input and output signal cables from the subwoofer.  
If the noise goes away, it is probably coming from the audio source or source cabling. It might be possible to eliminate the noise by disconnecting the ground from the input signals (activating ground lift).

To activate ground lift:

- ▶ Reconnect the signal cables and set the switch INPUT GROUND LIFT ⑬ to “INPUT GROUND LIFT”.  
This internally disconnects pin 1 of all 8 XLR sockets from the subwoofer electronics’ chassis ground (see table on page 11).

-  For safety reasons, the electronics chassis ground is always connected to the mains power earth pin.  
Even when ground lift is activated, the pins 1 of all audio inputs remain electronically connected to each other.

## Remote-controlling the system

**Using the NRC 1 remote control** Using a Neumann NRC 1 remote control (see page 16), you can remote control the following parameters:

- Adjustment of the system output level (level of the subwoofer and level of the signals available at the output sockets OUTPUT | LEFT, CENTER, RIGHT, LEFT/RIGHT SURROUND & LEFT/RIGHT BACK ⑪, see the section “Activating/deactivating the remote control for the level controls” on page 23)
- Activation/deactivation of the bass management (see page 20)
- 0 dB/+10 dB gain of the LFE channel (see page 20)

For information on the use of an NRC 1 remote control, please refer to its operating manual.

-  Note that no audio passes down the remote control cables, only control signals and data.

**Using a RS-232 data link** Using a RS-232 data link, you can remote control additional parameters of the subwoofer:

- Muting of all and/or individual channels
- Level control of individual channels
- Activation/deactivation of the bass management and rear bass management (see page 20)
- Activation/deactivation of the LFE channel gain (see page 20)
- Resetting of settings of the KH 810/870 (see page 23)

In addition, using a RS-232 data link, you can read out the following parameters:

- Muting of each channel
- Level of each channel
- Firmware revision

-  The PDF file “7.1\_bass\_manager\_control\_protocol” contains a list of the RS-232 commands that can be used to control the KH 810/870, and it can be downloaded from the KH 810/870 product page at [www.neumann.com](http://www.neumann.com).







### Activating/deactivating the remote control for the level controls



#### WARNING

Danger of hearing damage due to sudden high sound pressure levels!

If – with an audio signal present – you remove the Neumann NRC 1 remote control while the switch VOLUME CONTROL ①⑨ is set to “VOLUME CONTROL” or you set the switch VOLUME CONTROL ①⑨ to “DISABLE” while the Neumann NRC 1 remote control is connected, the system output level is immediately set to 0 dB. This can create sudden, very high sound pressure levels which can damage your hearing.

- ▶ Always lower the output level of the audio source **before** removing a connected Neumann NRC 1 remote control or – with the remote control connected – setting the switch VOLUME CONTROL to “DISABLE”.

To be able to use the remote control for adjusting the level controls, you have to **activate** this function:

- ▶ Set the switch VOLUME CONTROL ①⑨ to “ACTIVE”.  
You can now remote control the system output level.

To **deactivate** the remote control for the level controls or to remove the remote control cable from the socket REMOTE CONTROL AND RS-232 ①⑫:

If you are using the Neumann NRC 1 remote control:

- ▶ First, make sure that no high-level audio signals are present.
- ▶ Set the switch VOLUME CONTROL ①⑨ to “DISABLE”.  
The system output level is automatically reset to 0 dB and you can now remove the remote control cable from the socket REMOTE CONTROL AND RS-232 ①⑫.

If you are using an RS-232 control:

- ▶ Remove the cable of the RS-232 control from the socket REMOTE CONTROL AND RS-232 ①⑫.  
The system output level continues at the level value last send to the subwoofer.

To reset the system output level to 0 dB:

- ▶ Switch the subwoofer off and on again.  
or
- ▶ Set the switch VOLUME CONTROL ①⑨ to “DISABLE”.



## Resetting the settings of the KH 810/870

If you control the KH 810/870 using the RS-232 protocol, you can change ...

- settings that you cannot make using the switches on the rear of the KH 810/870;
- settings that deviate from the actual position of the switches of the KH 810/870.

To reset the KH 810/870 to the factory default settings or to reset the settings of the switches on the rear of the subwoofer:

- ▶ Switch the subwoofer off and on again by setting the switch MAINS POWER ⑤ to “OFF” and then to “ON”.
- ▶ Within 5 seconds after switch-on, move the switch REAR CH BASS MANAGEMENT ⑱ at least three times to the left and right.  
If resetting was successful, the LEDs POWER ON ⑮ and BASS MANAGEMENT ⑲ alternately flash for approx. 2 seconds and the subwoofer then restarts.

The following settings are reset:

Setting	Factory default setting
Output level of the subwoofer	Setting of the switch SUBWOOFER GAIN   OUTPUT LEVEL ⑳
Level of all or individual signals at the sockets OUTPUT   LEFT/RIGHT BACK, LEFT/RIGHT SURROUND, LEFT, CENTER & RIGHT ⑪	0 dB
Muting of all and/or individual channels	No muting
Activation/deactivation of the bass management	Setting of the switch BASS MANAGEMENT ⑰
Activation/deactivation of the rear channel bass management	Setting of the switch REAR CH BASS MANAGEMENT ⑱
Gain of the LFE channel	Setting of the switch LFE GAIN ㉔



## Cleaning and maintaining the subwoofer

### CAUTION

Damage to the product caused by liquids!

Liquids entering the product can cause a short-circuit in the electronics and damage or even destroy the product.

▶ Keep all liquids away from the product.

- ▶ Before cleaning, disconnect the product from the mains power supply (see page 15).
- ▶ Use a soft, dry, and lint-free cloth to clean the product.

## Troubleshooting

Problem	Cause	Solution
There is hum or buzz coming from the KH 810/870 when an audio cable is connected.	A cable is defective, the cabling is bad, there is ground loop in the installation or the level of the audio source is too low.	Check all cabling to eliminate the cause of the problem, use balanced cables, use the ground lift switch (see page 22) or send higher signal levels from your source and reduce the level on your subwoofer and your monitors.
The bass management of the audio outputs OUTPUT   LEFT/RIGHT BACK ⑪ does not seem to work, even though the switch REAR CH BASS MANAGEMENT ⑱ is set to the left.	The switch BASS MANAGEMENT ⑰ is set to “DISABLE”. This also deactivates the bass management of the audio outputs OUTPUT   LEFT/RIGHT BACK ⑪.	Set the switch BASS MANAGEMENT ⑰ to “BASS MANAGEMENT”.
There is a sudden reduction of the subwoofer’s output level, the LED POWER ON ⑮ flashes slowly, the output level is reduced by 6 dB.	The temperature of the power amplifier is too high.	Ensure sufficient ventilation of the subwoofer and/or reduce the input signal level, or add extra subwoofers to increase LF headroom. When the temperature has dropped again, the LED POWER ON ⑮ lights up constantly and the output level reduction is canceled.
The level controls on the rear of the subwoofer behave different than expected.	The values of the switches have been changed by the remote control for the level controls.	Deactivate the remote control for the level controls. To do so, read and follow the instructions and warning notes on page 23. If necessary, reset the settings of the KH 810/870 (see page 23).
The LED POWER ON ⑮ goes off in time with high-energy, low-frequency signals.	The signal level is too high, the protection system is active.	Reduce the signal level.

For further information, please refer to the “Questions & Answers” section at [www.neumann.com](http://www.neumann.com).



## Specifications

Acoustics	KH 870	KH 810
-3 dB free field frequency response	18 Hz to 300 Hz, $\pm 3$ dB	
Pass band free field frequency response	19 Hz to 300 Hz, $\pm 2$ dB	
Self-generated noise (with input gain set to 100 dB for 0 dBu)	< 20 dB(A) at 10 cm	
Total harmonic distortion < 0.5 % at 95 dB SPL at 1 m	>40 Hz	>45 Hz
Max. SPL in half space with 3% THD at 1 m, averaged between 40 Hz and 90 Hz	116.7 dB SPL	110.7 dB SPL
Max. SPL with pink noise in half space at 1 m, linear	118 dB SPL	112 dB SPL
Electronics	KH 870	KH 810
Amplifier, continuous (peak) output power	320 W (400 W)	160 W (200 W)
THD and noise at continuous load	< 0.1 % (-60 dB) with deactivated limiter	
Controller design	analog, active	
Crossover frequency of main channels	80 Hz	
Crossover slope	24 dB/oct., 4 <sup>th</sup> order	
Acoustical control   Low cut	center frequency: 30 Hz Q factor = 1.5 gain range: 0 to -12 dB	
Acoustical control   Parametric equalizer	bypassable gain: +4 to -12 dB frequency: 20 Hz to 120 Hz Q factor: 1 to 8	
Time of flight adjustment delay	0° to -315°, adjustable in steps of 45°	
Volume control	100 dB SPL, 114 dB SPL	
Input sensitivity	-12 dB ... +2 dB	
Calibration tools	internal signal generator	
Protection circuitry	peak and thermal limiters	
Infrasonic filter frequency; slope	6.5 Hz; 12 dB/oct.	
Remote control	via cable remote control and RS-232	
Analog inputs and outputs		
Input/output channels	7.1 / 7+Sum	
Impedance, electrically balanced	XLR, 13 k $\Omega$	
Input sensitivity	-8 dBu/ +6 dBu (switchable)	
CMRR of inputs	>60 dB at 15 kHz	
Max. input level	+19 dBu (6.9 V)	
Cross-talk between channels (1 kHz)	< -95 dB	
Level matching	$\pm 0.1$ dB	
Volume control range (via remote control)	118 dB, 0.25 dB steps	
Dynamic range, THD+N	119 dB(A), < 0.001% at -100 dB	
LFE modes	80 +re-routing, 80, 120, fullrange	
LFE gain	0 dB / +10 dB (switchable)	
Gain control	+2 ... -12 dB	



Displays	KH 870	KH 810
Switch-on indicator	red LED lights up (and remote control logo)	
Limit/clip	red LED "flashing" (and remote control logo)	
Bass management active	green LED lights up	
Product properties	KH 870	KH 810
Mains voltage	220 ... 240 or 100 ... 120 V AC switchable, 50/60 Hz	
Power consumption (idle)	25 W	20 W
Power consumption (full output AC)	550 W	290 W
Dimensions (H x W x D)	735 x 330 x 645 mm	360 x 330 x 645 mm
Internal net volume/external volume	86.0 l/156.0 l	41.5 l/76.6 l
Weight	47.1 kg (103.6 lbs)	26.0 kg (57.2 lbs)
Driver(s)	magnetically shielded 2 x 265 mm (2 x 10")	magnetically shielded 1 x 265 mm (1 x 10")
Mounting points	mounting flange (∅ 38 mm/1.5") on upper side	–
Cabinet surface finish, color	painted wood (MDF), anthracite (RAL 7021)	
Driver protection	metal grille	
Operating conditions		
Ambient temperature	+10°C to +40°C (+50°F to +104°F)	
Relative humidity	max. 90% (non-condensing)	
Transport/storage conditions		
Ambient temperature	–25°C to +70°C (–13°F to +158°F)	
Relative humidity	max. 90 % (non-condensing)	
In compliance with		
Europe	EMC	EN 55103-1/-2, Electromagnetic Environment: Class E4
	Safety	EN 60065
USA	47 CFR 15 subpart B	
Canada	ICES-003	

### Acoustical measurements, block diagram and pin assignment

Additional technical data such as acoustical measurements, a block diagram of the KH 810/870 and the pin assignments of the XLR socket and the REMOTE CONTROL AND RS-232 socket can be found at the end of this operating manual.



## Accessories

Product	Description
FO 810	Flight case for KH 810
FO 870	Flight case for KH 870
RC 2	Remote control cable, 2 m
RC 5	Remote control cable, 5 m
RC 10	Remote control cable, 10 m
RC 15	Remote control cable, 15 m
RC 20	Remote control cable, 20 m
RC 25	Remote control cable, 25 m
RC 30	Remote control cable, 30 m
REK 3	Remote electronics kit
SC 2	Subwoofer cable, 2 m
SC 5	Subwoofer cable, 5 m
SC 10	Subwoofer cable, 10 m
SC 15	Subwoofer cable, 15 m
SC 20	Subwoofer cable, 20 m
SC 25	Subwoofer cable, 25 m
SC 30	Subwoofer cable, 30 m
SEA 1	Subwoofer EtherCon adapter
NRC 1	Subwoofer remote control

Some hardware for mounting loudspeakers on top of KH 870 subwoofers is also available. For further information and the complete range of Neumann mounting hardware parts and how they can be used, refer to the PDF file “Hardware Mounting Matrix” that can be downloaded from [www.neumann.com](http://www.neumann.com). Detailed mechanical drawings of the Neumann products are also available there.



## Manufacturer Declarations

### Guarantee

For the current terms and conditions of the product guarantee, please visit [www.neumann.com](http://www.neumann.com).

### In compliance with the following requirements



- WEEE (2002/96/EC)

Please dispose of the product at the end of its operational lifetime by taking it to your local collection point or recycling center for such equipment.



### CE Declaration of Conformity

- RoHS (2011/65/EU)
- Low Voltage Directive (2006/95/EC)
- EMC Directive (2004/108/EC)

The declaration is available on the product page at [www.neumann.com](http://www.neumann.com).

### Certified by



Audio, Video and Similar Electronic Apparatus - Safety Requirements CAN/CSA C22.2 No. 60065-03 Incl. AM1 and UL Std. No. 60065-2007

### Trademarks

Neumann® is a registered trademark of Georg Neumann GmbH. The following are trademarks of Georg Neumann GmbH:

- Plane Wave Bass Array™ and PWBA™

Other company, product, or service names mentioned in this operating manual may be the trademarks, service marks, or registered trademarks of their respective owners.

### FCC

This device complies with Part 15 of the FCC Rules. Operation is subject to the following two conditions: (1) this device may not cause harmful interference, and (2) this device must accept any interference received, including interference that may cause undesired operation.

This class B digital apparatus complies with the Canadian ICES-003.

Changes or modifications made to this equipment not expressly approved by Neumann may void the FCC authorization to operate this equipment.



## Technical information & glossary

**Absolute level** In Europe, the absolute level of 0 dBu is –18 dBFS (EBU standard R68). In the US, +4 dBu is –20 dBFS (SMPTE standard RP155). These dBu values should lead to the following sound pressure levels:

Application	Sound pressure level
Film	85 dB(C)
Broadcast	79 dB(C) (reference level)
Music	No defined reference levels

Near field loudspeakers can be as close as 1 m from the listening position, whereas loudspeakers in a Dolby certified movie mixing room should be at least 5 m from the listening position.

In the examples below, it is assumed that the listener is inside the room radius and thus the sound field decays according to  $20 \log_{10}(r)$ , however this may not always be the case.

Absolute voltage level of input signal	0 dBu (0.775 V)	+4 dBu (1.23 V)
Setting SUBWOOFER GAIN   INPUT GAIN ②	–1 dB	–5 dB
Setting SUBWOOFER GAIN   OUTPUT LEVEL ②①	100	100
Listening distance [m] (dB change)	5 m (–14 dB)	5 m (–14 dB)
Measured output level in dB SPL at 1 m	85 dB SPL	85 dB SPL
Maximum input signal before activation of the protection system	17 dBu	17 dBu

Absolute acoustic level calibration for signal channels is generally achieved using a sound level meter set to “C-weighted” and “Slow”. Play a broadband pink noise test signal set to –18 dBFS (Europe) or –20 dBFS (USA) on the console meters and measure the sound pressure level at the listening position. Then adjust each channel’s source level, not the loudspeakers and subwoofer(s) so that the above stated sound pressure levels are achieved.

**Acoustical axis** The acoustical axis is a line perpendicular to the subwoofer’s front panel along which the microphone was placed when tuning the subwoofer’s crossover during design. The acoustical axis is located at the midpoint of the KH 810’s bass driver or at the midpoint of the bass drivers of the KH 870.

**Acoustical controls** The acoustical controls are low-order analog filters designed to compensate for some of the acoustical issues commonly found in listening environments. The acoustical controls’ settings will depend on the subwoofer’s location and will probably be different for the same subwoofer type positioned in different locations in the same room. When calibrating subwoofers there are three areas requiring attention: in-room response, level relative to main loudspeakers, and phase relative to main loudspeakers.





**Acoustical output level**

Depending on the setting of the potentiometer SUBWOOFER GAIN | INPUT GAIN ② and the switch SUBWOOFER GAIN | OUTPUT LEVEL ① – and referred to an input signal level of 0 dBu – the following acoustical output levels can be obtained:

Setting of potentiometer SUBWOOFER GAIN   INPUT GAIN ②	Acoustic output level [dB SPL] of the subwoofer at 1 m when input signal level is 0 dBu	
	Setting of switch SUBWOOFER GAIN   OUTPUT LEVEL ① = 100 dB	Setting of switch SUBWOOFER GAIN   OUTPUT LEVEL ① = 114 dB
-12 dB	88 dB SPL	102 dB SPL
-10 dB	90 dB SPL	104 dB SPL
-8 dB	92 dB SPL	106 dB SPL
-6 dB	94 dB SPL	108 dB SPL
-4 dB	96 dB SPL	110 dB SPL
-2 dB	98 dB SPL	112 dB SPL
0 dB	100 dB SPL	114 dB SPL
+2 dB	102 dB SPL	116 dB SPL

The default setting is SUBWOOFER GAIN | INPUT GAIN ② = “0 dB” and SUBWOOFER GAIN | OUTPUT LEVEL ① = “100 dB SPL at 1 m”, which corresponds to a sound pressure level of 100 dB SPL measured at a distance of 1 m, when the input signal has a level of 0 dBu.

Using the potentiometer SUBWOOFER GAIN | INPUT GAIN ② and the switch SUBWOOFER GAIN | OUTPUT LEVEL ①, you can compensate for level differences due to acoustical loading (see page 10) and due to different distances of the subwoofers and loudspeakers from the listening position.

Examples of how to calculate sound pressure levels as a function of the input signal levels and input and output levels of the KH 810/870:

Absolute voltage level of input signal	0 dBu (0.775 V)	+4 dBu (1.23 V)	+6 dBu (1.55 V)	+16 dBu (4.89 V)
Setting SUBWOOFER GAIN   INPUT GAIN ②	0	0	0	0
Setting SUBWOOFER GAIN   OUTPUT LEVEL ①	100	100	100	100
Measured output level in dB SPL at 1 m	100	104	106	116

**Acoustical response**

Neumann subwoofers are designed to have a flat pass band magnitude response in anechoic conditions when all the acoustical controls are set to 0 dB. When a subwoofer is installed into a listening environment the response changes and thus should be corrected back to a flat response. It is therefore expected that the acoustical controls will need adjustment to improve the in-situ response of the subwoofer. The acoustical controls’ settings depend on the subwoofer’s location and will probably be different for the same subwoofer type installed in different locations in the same room. Moving the cabinet small distances, 50 cm (20”), can dramatically change the response therefore resulting in different acoustical control settings.

Graphs of acoustical measurements conducted in anechoic conditions at a distance 1 m can be found at the end of this operating manual. Color versions of these graphs can be found on the corresponding product pages at [www.neumann.com](http://www.neumann.com).



- Analog output card** The analog output card has seven channels of 4th order 80 Hz high pass filtering and a level control for each of these channels. Following this, there are seven electronically balanced output stages, whose signal is present at the sockets OUTPUT | LEFT/RIGHT BACK, LEFT/RIGHT SURROUND, LEFT, CENTER and RIGHT. All outputs (main channels and sum) have protective circuits to avoid power on/off noises: the outputs switch on after a short delay when mains power is applied and mute instantaneously when mains power is removed.
- If you select the corresponding mode, there is also 80 Hz high pass filtering and summing of the LFE channel to the left and right outputs (more details can be found in the section “Boosting the LFE channel and adjusting the LFE mode” on page 20).
- The socket OUTPUT | SUM ⑩ allows you to connect additional subwoofers. There is no volume control on this output as volume control is performed locally in each subwoofer.
- Crossover** Using 4<sup>th</sup> order filters, the crossover divides the input signal of each channel into two bands for reproduction by the subwoofer or the main loudspeakers. The crossover frequency is fixed at 80 Hz for all the main channels and can be bypassed when required. This frequency was chosen to balance the conflicting requirements of having a high crossover frequency to relieve the main loudspeakers of their low frequency duties thereby reducing distortion, and of the need to have a low crossover frequency to minimize the chances of localizing the subwoofer thereby giving greater flexibility when placing the subwoofer in the room. In addition, by choosing 80 Hz, there is a compatibility with the replay conditions commonly found in consumer products.
- Driver(s)** Long throw, efficient, low distortion drivers ensure a clean sound quality even at high replay levels. The drivers are loaded by the internal volume of the cabinet and are magnetically shielded for use next to CRT screens and magnetic storage media.
- LFE channel** “Low Frequency Effects” (Dolby) or “Low Frequency Enhancement” (dts). The LFE channel has a limited bandwidth. Because of the limited frequency range of the LFE channel, it is referred to as “.1” when describing, for example, a 5.1 system. The designation “LFE channel” always refers to the source and not to the loudspeakers.
- Power amplifier(s)** The high efficiency power amplifiers of the KH 810/870 minimize power dissipation and are run in bridged mode to minimize distortion.
- Protection system** An extensive protection system prevents damage to the subwoofer if high signal levels are applied to the input. The LED POWER ON ⑮ flashes when the protection system is active. In this case, reduce the input signal level. If this happens regularly, use a larger subwoofer with a higher SPL output or add more subwoofers to the system to increase the LF headroom.
- The protection system consists of thermal and peak limiters for the amplifier(s) and thermal modeling of the driver(s). The protection system is not a compressor, it is designed to protect the subwoofer from damage. The protection system cannot protect against sustained abuse of the loudspeaker system, i.e. playing the subwoofer for long periods of time with the LED POWER ON ⑮ flashing. Please avoid consistent abuse of the subwoofer to not affect the long service life of the product.
- Remote switch-on/switch-off** A 12 V DC trigger voltage allows you to remotely switch the subwoofer on and off without having to use the switch MAINS POWER ⑤. This can be useful in a large installation where the whole room is powered up using a single switch. The devices are switched on using a time-delay to prevent high starting current peaks. The trigger voltage switches the subwoofer’s electronics completely on and off, so the startup time is subject to the same on/off muting delays as if the subwoofer had been switched on and off using the switch MAINS POWER ⑤.



**RS-232 control**

If the control equipment outputs RS-232 data on D-sub connectors, an RS-232 to CAT5 cable is required. Only pins 3, 4 and 5 should be connected. Pins 4 and 5 should be crossed over, i.e. TX connects to RX and vice versa.

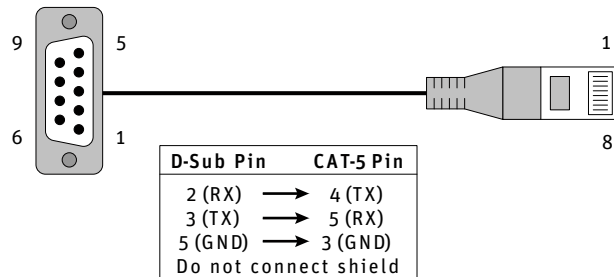

**RS-232 D-sub to CAT5 adapter**

If the control equipment has a USB connector, for example a computer, a USB to RS-232 adapter is required – these are available from most large computer shops. Once the USB is converted to RS-232, an RS-232 to CAT5 adapter is required to connect to the subwoofer (see diagram above). Only connect the three pins indicated in the diagram otherwise damage may occur to the USB to RS-232 adapter.

**Volume control**

The VOL stages are located at the main channel outputs of the 7.1 High Definition Bass Manager™ and the subwoofer output. As a result, they can be used for controlling the replay level of the entire system or for remotely trimming individual loudspeaker levels.

Consequently, they cannot be used to replicate signal SOLO or SELECT type functions as seen in mixing consoles. However, it is possible to MUTE and SOLO one or more of the loudspeaker outputs using an RS-232 control.

This is useful when setting up the system – play some bass-heavy material at high levels with all the main loudspeakers muted (subwoofer is soloed) to find the source of rattles in the listening room. Using subwoofer mute and bass management together gives some useful additional functionality:

Bass management	Subwoofer	Bass extension (–3 dB)
ON	ON	18 Hz
ON	MUTED	80 Hz
DISABLE	ON	Main loudspeaker's LF cut-off
DISABLE	MUTED	Main loudspeaker's LF cut-off





## System block diagram/System-Blockdiagramm/ Synoptique système/Diagrama de bloques del sistema

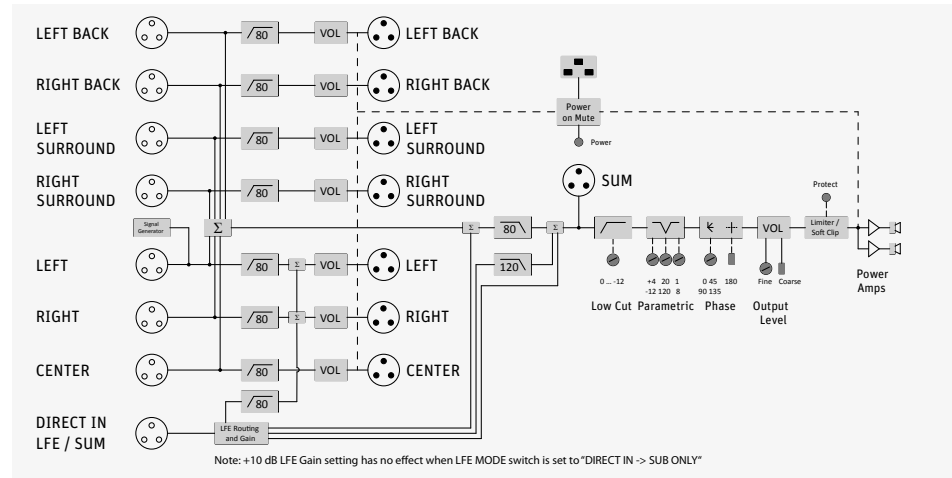

## Pin assignment of the XLR socket/Buchsenbelegung XLR/ Brochage de la prise XLR/Asignación de la hembra XLR

1	Audio ground/Audio-Erdung/Masse audio/Toma de tierra de audio	
2	Signal +/Signal +/Signal +/Señal +	
3	Signal -/Signal -/Signal -/Señal -	

## Pin assignment of the REMOTE CONTROL AND RS-232 socket/Anschlussbelegung der Buchse REMOTE CONTROL AND RS-232/Brochage de la prise REMOTE CONTROL AND RS-232/Asignación de conexiones de la hembra REMOTE CONTROL AND RS-232

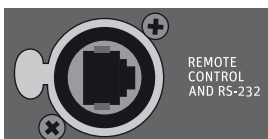

Function/Funktion/Fonction/Función	RJ-45 pins/Buchsenbelegung der RJ-45 Pole/Cablage des broches RJ-45/Asignación de las hembras de los polos RJ-45
Volume control	1
LOGO voltage	2
GND*	3
RS 232 TX*	4
RS 232 RX*	5
Supply voltage +3.3 V	6
Bypass bass management	7
+10 dB LFE gain	8

\* RS-232 data connection



EN	The PDF file “7.1 High Definition Bass Manager Remote Control Wiring Diagram” contains a wiring diagram for making your own hardware remote control for the KH 810/870. You can download it from the KH 810/870 product page at <a href="http://www.neumann.com">www.neumann.com</a> .
DE	In der PDF-Datei „7.1 High Definition Bass Manager Remote Control Wiring Diagram“ finden Sie einen Schaltplan, mit dessen Hilfe Sie eine individuelle Fernbedienung für den KH 810/870 anfertigen können. Sie finden die PDF-Datei auf der KH 810/870-Produktseite unter <a href="http://www.neumann.com">www.neumann.com</a> .
FR	Le fichier PDF « 7.1 High Definition Bass Manager Remote Control Wiring Diagram » contient un schéma de brochage pour confectionner une télécommande individuelle pour le KH 810/870. Vous pouvez télécharger ce fichier PDF depuis la fiche produit du KH 810/870 sur <a href="http://www.neumann.com">www.neumann.com</a> .
ES	En el archivo PDF «7.1 High Definition Bass Manager Remote Control Wiring Diagram» se encuentra un diagrama para hacer su propio control remoto para el KH 810/870. Puede descargarlo en la página del producto KH 810/870 de <a href="http://www.neumann.com">www.neumann.com</a> .

### Acoustical measurements/Akustische Messungen/ Mesures acoustiques/Mediciones acústicas

EN	Below are acoustical measurements conducted in anechoic conditions at 1 m. Color versions of these graphs can be found on the appropriate product page of the web site.
DE	Die folgenden akustischen Messungen wurden unter reflexionsarmen Bedingungen bei 1 m Abstand durchgeführt. Farbversionen dieser Diagramme finden Sie auf den entsprechenden Produktseiten der Neumann Website.
FR	Vous trouverez ci après les courbes correspondant aux mesures acoustiques effectuées en chambre sourde, à une distance de 1 mètre du moniteur. Vous retrouverez ces courbes, en couleur, dans la section appropriée de notre site Web.
ES	Las siguientes mediciones acústicas se han realizado bajo condiciones de baja reflexión a una distancia de 1 m. Encontrará versiones a color de estos diagramas en las páginas correspondientes de los productos en la página web de Neumann.

#### KH 870

<p>KH 870 + O 410 Free-field response Freifeld-Frequenzgang Réponse en champ libre Respuesta en frecuencia en campo libre</p>	<p>KH 870 + O 410 Group delay Gruppenlaufzeit Temps de propagation de groupe Retardo de grupo</p>

EN

DE

FR

ES



**KH 870**  
Distortion at 95 dB SPL  
Verzerrung bei 95 dB SPL  
THD à 95 dB SPL  
Distorsión con un SPL de 95 dB

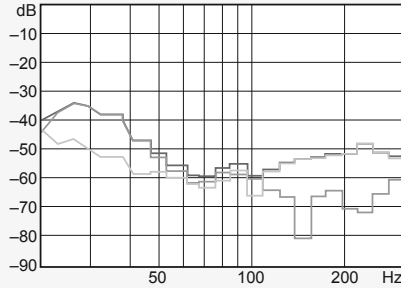

**KH 870**  
Maximum SPL at 1 m (1% and 3%)  
Maximaler SPL bei 1 m (1% und 3%)  
Niveau SPL maximal, à 1 m (1% et 3%)  
SPL máximo a 1 m (3% y 1%)

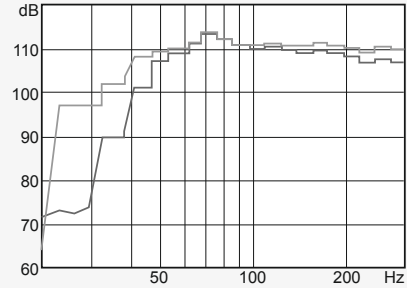

**KH 810**

**KH 810 + KH 120**  
Free-field response  
Freifeld-Frequenzgang  
Réponse en champ libre  
Respuesta en frecuencia en campo libre

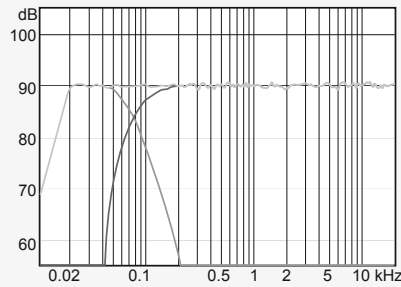

**KH 810 + KH 120**  
Group delay  
Gruppenlaufzeit  
Temps de propagation de groupe  
Retardo de grupo

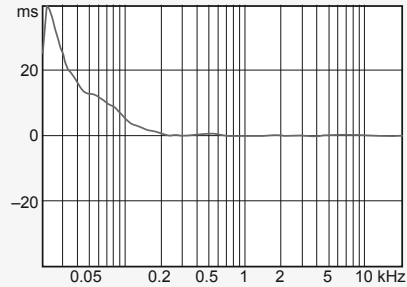

**KH 810**  
Harmonic distortion at 95 dB SPL  
Klirrfaktor bei 95 dB SPL  
Distorsion harmonique à 95 dB SPL  
Distorsión armónica total a 95 dB SPL

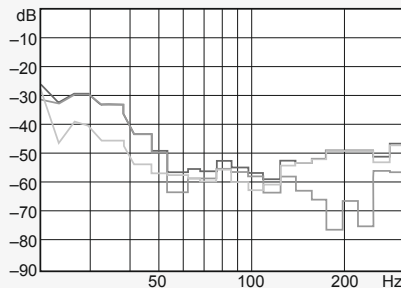

**KH 810**  
Maximum SPL at 1 m (1% and 3%)  
Maximaler SPL bei 1 m (1% und 3%)  
Niveau SPL maximal, à 1 m (1% et 3%)  
SPL máximo a 1 m (1% y 3%)

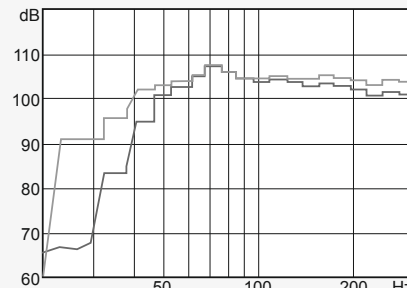

EN

DE

FR

ES



**Acoustical controls/Akustikregler/Acoustical Controls/Acoustical Controls**

Low Cut acoustical control  
Akustikregler: Low Cut  
Action du potentiomètre Low Cut  
Control de corte de bajos (Low Cut)

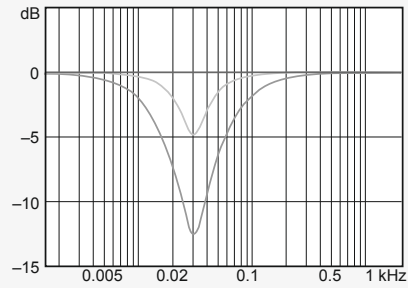

Parametric Equalizer  
Parametrischer Equalizer  
Action de l'égaliseur paramétrique  
Control del ecualizador paramétrico

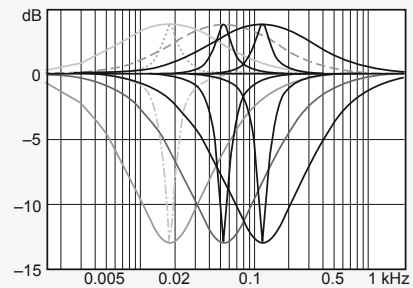

LFE channel electrical response  
Elektrischer Frequenzgang LFE-Kanal  
Courbe de réponse électrique du canal LFE  
Respuesta eléctrica del canal LFE

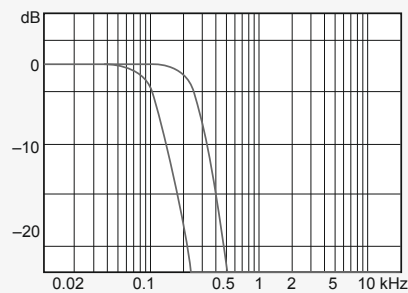

EN

DE

FR

ES





